

Data sheet | Item number: 745-841

Stackable PCB terminal block; 6 mm²; Pin spacing 10 mm; 1-pole; CAGE CLAMP®; commoning option; 6,00 mm²; gray

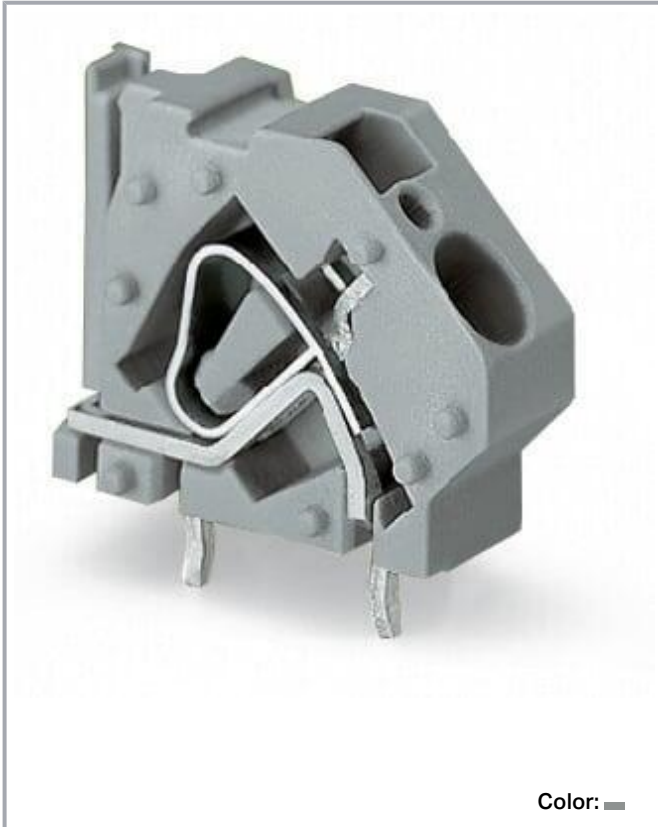

www.wago.com/745-841



Color:

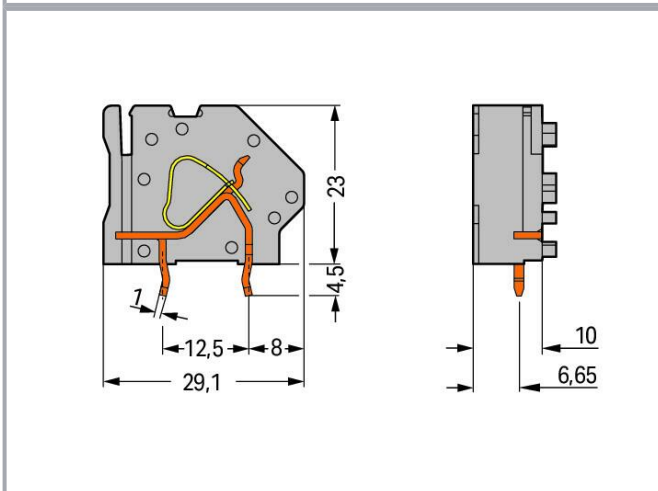
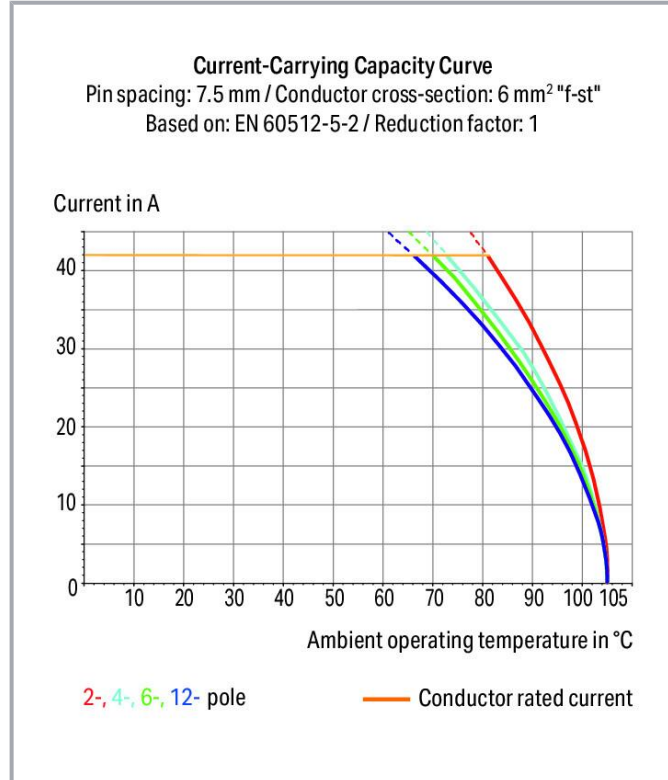

Subject to changes. Please also observe the further product documentation!

WAGO GmbH & Co. KG
Hansastr. 27
32423 Minden
Phone: +49571 887-0 | Fax: +49571 887-169
Email: info.de@wago.com | Web: www.wago.com

Do you have any questions about our products?
We are always happy to take your call at +49 (571) 887-44222.



Item description

- Modular terminal blocks with screwdriver-actuated CAGE CLAMP® for custom terminal strip assemblies
- Versions with Ex approval
- Common and distribute potentials via comb-style jumper bars
- Double solder pins for high mechanical stability
- Integrated testing tap
- Marker slot for Mini-WSB markers

Data

Notes

Variants:

Versions for Ex e II and Ex i

Other colors

Other versions (or variants) can be requested from WAGO Sales or configured at <https://configurator.wago.com/>.

Electrical data

Ratings per IEC/EN

| Ratings per | IEC/EN 60664-1 |
|-------------------------------|---|
| Nominal voltage (III/3) | 630 V |
| Rated impulse voltage (III/3) | 8 kV |
| Rated voltage (III/2) | 1000 V |
| Rated impulse voltage (III/2) | 8 kV |
| Nominal voltage (II/2) | 1000 V |
| Rated surge voltage (II/2) | 8 kV |
| Rated current | 41 A |
| Legend (ratings) | (III / 2) ≙ Overvoltage category III / Pollution degree 2 |

Ratings per UL 1059

| Approvals per | UL 1059 |
|--------------------------------|---------|
| Rated voltage UL (Use Group B) | 300 V |
| Rated current UL (Use Group B) | 30 A |
| Rated voltage UL (Use Group C) | 150 V |
| Rated current UL (Use Group C) | 30 A |
| Rated voltage UL (Use Group D) | 300 V |
| Rated current UL (Use Group D) | 10 A |

Subject to changes. Please also observe the further product documentation!

WAGO GmbH & Co. KG

Hansastr. 27

32423 Minden

Phone: +49571 887-0 | Fax: +49571 887-169

Email: info.de@wago.com | Web: www.wago.com

Do you have any questions about our products?

We are always happy to take your call at +49 (571) 887-44222.



Ratings per CSA

| Approvals per | CSA |
|---------------------------------|-------|
| Rated voltage CSA (Use Group B) | 300 V |
| Rated current CSA (Use Group B) | 30 A |
| Rated voltage CSA (Use Group C) | 150 V |
| Rated current CSA (Use Group C) | 30 A |
| Rated voltage CSA (Use Group D) | 300 V |
| Rated current CSA (Use Group D) | 10 A |

Connection data

| | |
|----------------------------|---|
| Connection points | 1 |
| Total number of potentials | 1 |
| Number of connection types | 1 |
| Number of levels | 1 |
| Number of jumper slots | 1 |

Connection 1

| | |
|---|---|
| Connection technology | CAGE CLAMP® |
| Actuation type | Operating tool |
| Solid conductor | 0.2 ... 6 mm ² / 24 ... 10 AWG |
| Fine-stranded conductor | 0.2 ... 6 mm ² / 24 ... 10 AWG |
| Fine-stranded conductor; with insulated ferrule | 0.25 ... 4 mm ² |
| Fine-stranded conductor; with uninsulated ferrule | 0.25 ... 4 mm ² |
| Strip length | 11 ... 12 mm / 0.43 ... 0.47 inches |
| Conductor connection direction to PCB | 45 ° |
| Pole number | 1 |

Physical data

| | |
|--------------------------------------|--------------------------|
| Pin spacing | 10 mm / 0.394 inches |
| Width | 11.5 mm / 0.453 inches |
| Height | 27.5 mm / 1.083 inches |
| Height from the surface | 23 mm / 0.906 inches |
| Depth | 29.1 mm / 1.146 inches |
| Solder pin length | 4.5 mm |
| Solder pin dimensions | 1 x 1.4 mm |
| Drilled hole diameter with tolerance | 1.8 ^(+0.1) mm |

Subject to changes. Please also observe the further product documentation!



Plug-in connection

| | |
|--------------------------------------|----|
| Plugging without loss of pin spacing | No |
|--------------------------------------|----|

PCB contact

| | |
|-------------------------------------|-------------------------------------|
| PCB contact | THT |
| Solder pin arrangement | within the terminal block (in-line) |
| Number of solder pins per potential | 2 |

Material Data

Note (material data)

Information on material specifications can be found here

| | |
|-----------------------------|--|
| Color | gray |
| Material group | I |
| Insulation material | Polyamide (PA66) |
| Flammability class per UL94 | V0 |
| Clamping spring material | Chrome-nickel spring steel (CrNi) |
| Contact material | Electrolytic copper (E _{Cu}) |
| Contact plating | Tin |
| Fire load | 0.092 MJ |
| Weight | 5.4 g |

Environmental requirements

| | |
|-------------------------|-----------------|
| Limit temperature range | -60 ... +105 °C |
|-------------------------|-----------------|

Commercial data

| | |
|-------------------|--------------------------------|
| Product Group | 4 (Printed Circuit Connectors) |
| eCl@ss 10.0 | 27-44-04-01 |
| eCl@ss 9.0 | 27-44-04-01 |
| ETIM 8.0 | EC002643 |
| ETIM 7.0 | EC002643 |
| PU (SPU) | 100 (50) pcs |
| Packaging type | box |
| Country of origin | PL |
| GTIN | 4044918302685 |

Subject to changes. Please also observe the further product documentation!

Customs tariff number

85369010000





Environmental Product Compliance

RoHS Compliance Status



Compliant, No Exemption

Approvals / Certificates

General approvals

| Logo | Approval | Additional Approval Text | Certificate name |
|--|--------------------------------------|--------------------------|------------------|
|  | CCA DEKRA Certification B.V. | EN 60947 | NTR NL-7097 |
|  | CCA DEKRA Certification B.V. | EN 60947 | 2160584.16 |
|  | CSA DEKRA Certification B.V. | C22.2 No. 158 | 1604421 |
|  | UR Underwriters Laboratories Inc. | UL 1059 | E45172 |

Declarations of conformity and manufacturer's declarations

| Logo | Approval | Additional Approval Text | Certificate name |
|--|--|--------------------------|------------------|
|  | EU-Declaration of Conformity WAGO GmbH & Co. KG | - | - |
|  | UK-Declaration of Conformity WAGO GmbH & Co. KG | - | - |

Required accessories

Mounting

Intermediate plate

Subject to changes. Please also observe the further product documentation!

WAGO GmbH & Co. KG

Hansastr. 27





32423 Minden

Phone: +49571 887-0 | Fax: +49571 887-169











Email: info.de@wago.com | Web: www.wago.com

Do you have any questions about our products?

We are always happy to take your call at +49 (571) 887-44222.

| | | |
|--|---|--|
|  | Item no.: 745-338 Spacer; for extending the pin spacing; 2.5 mm thick; gray | www.wago.com/745-338 |
| End plate | | |
| End plate | | |
|  | Item no.: 745-300 End plate; snap-fit type; 1.6 mm thick; gray | www.wago.com/745-300 |
|  | Item no.: 745-340 End plate; with flange; gray | www.wago.com/745-340 |
|  | Item no.: 745-345 End plate; with flange; gray | www.wago.com/745-345 |

Optional accessories

| | | |
|---|---|--|
| Ferrule | | |
| Ferrule | | |
|  | Item no.: 216-101 Ferrule; Sleeve for 0.5 mm ² / AWG 22; uninsulated; electro-tin plated; silver-colored | www.wago.com/216-101 |
|  | Item no.: 216-104 Ferrule; Sleeve for 1.5 mm ² / AWG 16; uninsulated; electro-tin plated; silver-colored | www.wago.com/216-104 |
|  | Item no.: 216-106 Ferrule; Sleeve for 2.5 mm ² / AWG 14; uninsulated; electro-tin plated; silver-colored | www.wago.com/216-106 |
|  | Item no.: 216-107 Ferrule; Sleeve for 4 mm ² / AWG 12; uninsulated; electro-tin plated | www.wago.com/216-107 |
|  | Item no.: 216-102 Ferrule; Sleeve for 0.75 mm ² / AWG 20; uninsulated; electro-tin plated; silver-colored | www.wago.com/216-102 |
|  | Item no.: 216-103 Ferrule; Sleeve for 1 mm ² / AWG 18; uninsulated; electro-tin plated | www.wago.com/216-103 |
|  | Item no.: 216-123 Ferrule; Sleeve for 1 mm ² / AWG 18; uninsulated; electro-tin plated; silver-colored | www.wago.com/216-123 |
|  | Item no.: 216-122 Ferrule; Sleeve for 0.75 mm ² / AWG 20; uninsulated; electro-tin plated; silver-colored | www.wago.com/216-122 |
|  | Item no.: 216-124 Ferrule; Sleeve for 1.5 mm ² / AWG 16; uninsulated; electro-tin plated | www.wago.com/216-124 |
|  | Item no.: 216-142 Ferrule; Sleeve for 0.75 mm ² / 18 AWG; uninsulated; electro-tin plated; electrolytic copper; gastight | www.wago.com/216-142 |

Subject to changes. Please also observe the further product documentation!

crimped; acc. to DIN 46228, Part 1/08.92

| | | |
|---|---|--|
| | Item no.: 216-132 Ferrule; Sleeve for 0.34 mm ² / AWG 24; uninsulated; electro-tin plated | www.wago.com/216-132 |
| | Item no.: 216-121 Ferrule; Sleeve for 0.5 mm ² / AWG 22; uninsulated; electro-tin plated; silver-colored | www.wago.com/216-121 |
| | Item no.: 216-143 Ferrule; Sleeve for 1 mm ² / AWG 18; uninsulated; electro-tin plated; electrolytic copper; gastight crimped; acc. to DIN 46228, Part 1/08.92 | www.wago.com/216-143 |
| | Item no.: 216-131 Ferrule; Sleeve for 0.25 mm ² / AWG 24; uninsulated; electro-tin plated; silver-colored | www.wago.com/216-131 |
| | Item no.: 216-141 Ferrule; Sleeve for 0.5 mm ² / 20 AWG; uninsulated; electro-tin plated; electrolytic copper; gastight crimped; acc. to DIN 46228, Part 1/08.92 | www.wago.com/216-141 |
| | Item no.: 216-152 Ferrule; Sleeve for 0.34 mm ² / AWG 24; uninsulated; electro-tin plated | www.wago.com/216-152 |
|  | Item no.: 216-203 Ferrule; Sleeve for 1 mm ² / AWG 18; insulated; electro-tin plated; red | www.wago.com/216-203 |
|  | Item no.: 216-206 Ferrule; Sleeve for 2.5 mm ² / AWG 14; insulated; electro-tin plated; blue | www.wago.com/216-206 |
|  | Item no.: 216-207 Ferrule; Sleeve for 4 mm ² / AWG 12; insulated; electro-tin plated; gray | www.wago.com/216-207 |
|  | Item no.: 216-202 Ferrule; Sleeve for 0.75 mm ² / 18 AWG; insulated; electro-tin plated; gray | www.wago.com/216-202 |
| | Item no.: 216-151 Ferrule; Sleeve for 0.25 mm ² / AWG 24; uninsulated; electro-tin plated | www.wago.com/216-151 |
|  | Item no.: 216-204 Ferrule; Sleeve for 1.5 mm ² / AWG 16; insulated; electro-tin plated; black | www.wago.com/216-204 |
|  | Item no.: 216-205 Ferrule; Sleeve for 2.08 mm ² / AWG 14; insulated; electro-tin plated; yellow | www.wago.com/216-205 |
| | Item no.: 216-144 Ferrule; Sleeve for 1.5 mm ² / AWG 16; uninsulated; electro-tin plated; electrolytic copper; gastight crimped; acc. to DIN 46228, Part 1/08.92; silver-colored | www.wago.com/216-144 |
|  | Item no.: 216-201 Ferrule; Sleeve for 0.5 mm ² / 20 AWG; insulated; electro-tin plated; white | www.wago.com/216-201 |
|  | Item no.: 216-223 Ferrule; Sleeve for 1 mm ² / AWG 18; insulated; electro-tin plated; red | www.wago.com/216-223 |
|  | Item no.: 216-241 Ferrule; Sleeve for 0.5 mm ² / 20 AWG; insulated; electro-tin plated; electrolytic copper; gastight crimped; acc. to DIN 46228, Part 4/09.90; white | www.wago.com/216-241 |

Subject to changes. Please also observe the further product documentation!

| | | |
|---|--|--|
|  | Item no.: 216-242 Ferrule; Sleeve for 0.75 mm ² / 18 AWG; insulated; electro-tin plated; electrolytic copper; gastight crimped; acc. to DIN 46228, Part 4/09.90; gray | www.wago.com/216-242 |
|  | Item no.: 216-222 Ferrule; Sleeve for 0.75 mm ² / 18 AWG; insulated; electro-tin plated; gray | www.wago.com/216-222 |
|  | Item no.: 216-221 Ferrule; Sleeve for 0.5 mm ² / 20 AWG; insulated; electro-tin plated; white | www.wago.com/216-221 |
|  | Item no.: 216-224 Ferrule; Sleeve for 1.5 mm ² / AWG 16; insulated; electro-tin plated; black | www.wago.com/216-224 |
|  | Item no.: 216-243 Ferrule; Sleeve for 1 mm ² / AWG 18; insulated; electro-tin plated; electrolytic copper; gastight crimped; acc. to DIN 46228, Part 4/09.90; red | www.wago.com/216-243 |
|  | Item no.: 216-244 Ferrule; Sleeve for 1.5 mm ² / AWG 16; insulated; electro-tin plated; electrolytic copper; gastight crimped; acc. to DIN 46228, Part 4/09.90; black | www.wago.com/216-244 |
|  | Item no.: 216-263 Ferrule; Sleeve for 1 mm ² / AWG 18; insulated; electro-tin plated; electrolytic copper; gastight crimped; acc. to DIN 46228, Part 4/09.90; red | www.wago.com/216-263 |
|  | Item no.: 216-246 Ferrule; Sleeve for 2.5 mm ² / AWG 14; insulated; electro-tin plated; electrolytic copper; gastight crimped; acc. to DIN 46228, Part 4/09.90; blue | www.wago.com/216-246 |
|  | Item no.: 216-266 Ferrule; Sleeve for 2.5 mm ² / AWG 14; insulated; electro-tin plated; electrolytic copper; gastight crimped; acc. to DIN 46228, Part 4/09.90; blue | www.wago.com/216-266 |
|  | Item no.: 216-264 Ferrule; Sleeve for 1.5 mm ² / AWG 16; insulated; electro-tin plated; electrolytic copper; gastight crimped; acc. to DIN 46228, Part 4/09.90; black | www.wago.com/216-264 |
|  | Item no.: 216-284 Ferrule; Sleeve for 1.5 mm ² / AWG 16; insulated; electro-tin plated; electrolytic copper; gastight crimped; acc. to DIN 46228, Part 4/09.90; black | www.wago.com/216-284 |
|  | Item no.: 216-286 Ferrule; Sleeve for 2.5 mm ² / AWG 14; insulated; electro-tin plated; electrolytic copper; gastight crimped; acc. to DIN 46228, Part 4/09.90; blue | www.wago.com/216-286 |
|  | Item no.: 216-287 Ferrule; Sleeve for 4 mm ² / AWG 12; insulated; electro-tin plated; electrolytic copper; gastight crimped; acc. to DIN 46228, Part 4/09.90; gray | www.wago.com/216-287 |
|  | Item no.: 216-262 Ferrule; Sleeve for 0.75 mm ² / 18 AWG; insulated; electro-tin plated; electrolytic copper; gastight crimped; acc. to DIN 46228, Part 4/09.90; gray | www.wago.com/216-262 |
|  | Item no.: 216-301 Ferrule; Sleeve for 0.25 mm ² / AWG 24; insulated; electro-tin plated; yellow | www.wago.com/216-301 |
|  | Item no.: 216-321 Ferrule; Sleeve for 0.25 mm ² / AWG 24; insulated; electro-tin plated; yellow | www.wago.com/216-321 |
|  | Item no.: 216-322 | |

Subject to changes. Please also observe the further product documentation!

Ferrule; Sleeve for 0.34 mm² / 22 AWG; insulated; electro-tin plated; light turquoise

www.wago.com/216-322



Item no.: 216-267

Ferrule; Sleeve for 4 mm² / AWG 12; insulated; electro-tin plated; electrolytic copper; gastight crimped; acc. to DIN 46228, Part 4/09.90; gray www.wago.com/216-267



Item no.: 216-302

Ferrule; Sleeve for 0.34 mm² / 22 AWG; insulated; electro-tin plated; light turquoise

www.wago.com/216-302

Jumpers

Jumper



Item no.: 745-390

Jumper; 10-way; silver-colored

www.wago.com/745-390



Item no.: 745-391

Jumper; 2-way; unplated; silver-colored

www.wago.com/745-391



Item no.: 745-393

Jumper; 3-way; silver-colored

www.wago.com/745-393



Item no.: 745-392

Jumper; 2-way; silver-colored

www.wago.com/745-392



Item no.: 745-395

Jumper; 5-way; unplated; silver-colored

www.wago.com/745-395



Item no.: 745-394

Jumper; 4-way; unplated; silver-colored

www.wago.com/745-394

Testing and measuring

Testing accessories



Item no.: 210-136

Test plug; 2 mm Ø; with 500 mm cable; red

www.wago.com/210-136

Tool

Operating tool



Item no.: 210-721

Operating tool; Blade: 5.5 x 0.8 mm; with a partially insulated shaft; multicoloured

www.wago.com/210-721

Marking accessories

Marker



Item no.: 2009-115/000-002

WMB-Inline; for Smart Printer; 1500 pieces on roll; stretchable 5 - 5.2 mm; plain; snap-on type; yellow

www.wago.com/2009-115/000-002



Item no.: 2009-115/000-007

WMB-Inline; for Smart Printer; 1500 pieces on roll; stretchable 5 - 5.2 mm; plain; snap-on type; gray

www.wago.com/2009-115/000-007

Subject to changes. Please also observe the further product documentation!

WAGO GmbH & Co. KG

Hansastr. 27

32423 Minden

Phone: +49571 887-0 | Fax: +49571 887-169

Email: info.de@wago.com | Web: www.wago.com

Do you have any questions about our products?

We are always happy to take your call at +49 (571) 887-44222.

| | | |
|---|---|--|
|  | Item no.: 2009-115/000-017 WMB-Inline; for Smart Printer; 1500 pieces on roll; stretchable 5 - 5.2 mm; plain; snap-on type; light green | www.wago.com/2009-115/000-017 |
|  | Item no.: 2009-115/000-023 WMB-Inline; for Smart Printer; 1500 pieces on roll; stretchable 5 - 5.2 mm; plain; snap-on type; green | www.wago.com/2009-115/000-023 |
|  | Item no.: 2009-115/000-024 WMB-Inline; for Smart Printer; 1500 pieces on roll; stretchable 5 - 5.2 mm; plain; snap-on type; violet | www.wago.com/2009-115/000-024 |
| | Item no.: 2009-145/000-006 Mini-WSB Inline; for Smart Printer; 1700 pieces on roll; stretchable 5 - 5.2 mm; plain; snap-on type; blue | www.wago.com/2009-145/000-006 |
| | Item no.: 2009-145 Mini-WSB Inline; for Smart Printer; 1700 pieces on roll; stretchable 5 - 5.2 mm; plain; snap-on type; white | www.wago.com/2009-145 |
| | Item no.: 2009-145/000-002 Mini-WSB Inline; for Smart Printer; 1700 pieces on roll; stretchable 5 - 5.2 mm; plain; snap-on type; yellow | www.wago.com/2009-145/000-002 |
| | Item no.: 2009-145/000-007 Mini-WSB Inline; for Smart Printer; 1700 pieces on roll; stretchable 5 - 5.2 mm; plain; snap-on type; gray | www.wago.com/2009-145/000-007 |
| | Item no.: 2009-145/000-005 Mini-WSB Inline; for Smart Printer; 1700 pieces on roll; stretchable 5 - 5.2 mm; plain; snap-on type; red | www.wago.com/2009-145/000-005 |
| | Item no.: 2009-145/000-012 Mini-WSB Inline; for Smart Printer; 1700 pieces on roll; stretchable 5 - 5.2 mm; plain; snap-on type; orange | www.wago.com/2009-145/000-012 |
| | Item no.: 2009-145/000-023 Mini-WSB Inline; for Smart Printer; 1700 pieces on roll; stretchable 5 - 5.2 mm; plain; snap-on type; green | www.wago.com/2009-145/000-023 |
| | Item no.: 2009-145/000-024 Mini-WSB Inline; for Smart Printer; 1700 pieces on roll; stretchable 5 - 5.2 mm; plain; snap-on type; violet | www.wago.com/2009-145/000-024 |
|  | Item no.: 2009-115 WMB-Inline; for Smart Printer; 1500 pieces on roll; stretchable 5 - 5.2 mm; plain; snap-on type; white | www.wago.com/2009-115 |
|  | Item no.: 248-501/000-006 Mini-WSB marking card; as card; not stretchable; plain; snap-on type; blue | www.wago.com/248-501/000-006 |

Subject to changes. Please also observe the further product documentation!



Item no.: 248-501/000-007
Mini-WSB marking card; as card; not stretchable; plain; snap-on type; gray

www.wago.com/248-501/000-007



Item no.: 248-501/000-002
Mini-WSB marking card; as card; not stretchable; plain; snap-on type; yellow

www.wago.com/248-501/000-002



Item no.: 248-501/000-012
Mini-WSB marking card; as card; not stretchable; plain; snap-on type; orange

www.wago.com/248-501/000-012



Item no.: 248-501
Mini-WSB marking card; as card; not stretchable; plain; snap-on type; white

www.wago.com/248-501



Item no.: 248-501/000-017
Mini-WSB marking card; as card; not stretchable; plain; snap-on type; light green

www.wago.com/248-501/000-017



Item no.: 248-501/000-005
Mini-WSB marking card; as card; not stretchable; plain; snap-on type; red

www.wago.com/248-501/000-005



Item no.: 248-501/000-024
Mini-WSB marking card; as card; not stretchable; plain; snap-on type; violet

www.wago.com/248-501/000-024



Item no.: 248-501/000-023
Mini-WSB marking card; as card; not stretchable; plain; snap-on type; green

www.wago.com/248-501/000-023



Item no.: 793-5501/000-007
WMB marking card; as card; for terminal block width 5 - 17.5 mm; stretchable 5 - 5.2 mm; plain; snap-on type; gray

www.wago.com/793-5501/000-007



Item no.: 793-5501/000-012
WMB marking card; as card; for terminal block width 5 - 17.5 mm; stretchable 5 - 5.2 mm; plain; snap-on type; orange

www.wago.com/793-5501/000-012



Item no.: 793-5501/000-017
WMB marking card; as card; for terminal block width 5 - 17.5 mm; stretchable 5 - 5.2 mm; plain; snap-on type; light green

www.wago.com/793-5501/000-017

Item no.: 793-5501/000-023

Subject to changes. Please also observe the further product documentation!



WMB marking card; as card; for terminal block width 5 - 17.5 mm; stretchable 5 - 5.2 mm; plain; snap-on type; green www.wago.com/793-5501/000-023



Item no.: 793-5501/000-024
WMB marking card; as card; for terminal block width 5 - 17.5 mm; stretchable 5 - 5.2 mm; plain; snap-on type; violet www.wago.com/793-5501/000-024



Item no.: 793-501/000-002
WMB marking card; as card; not stretchable; plain; snap-on type; yellow www.wago.com/793-501/000-002



Item no.: 793-501/000-007
WMB marking card; as card; not stretchable; plain; snap-on type; gray www.wago.com/793-501/000-007



Item no.: 793-501/000-017
WMB marking card; as card; not stretchable; plain; snap-on type; light green www.wago.com/793-501/000-017



Item no.: 793-501/000-012
WMB marking card; as card; not stretchable; plain; snap-on type; orange www.wago.com/793-501/000-012



Item no.: 793-501/000-023
WMB marking card; as card; not stretchable; plain; snap-on type; green www.wago.com/793-501/000-023



Item no.: 793-501/000-006
WMB marking card; as card; not stretchable; plain; snap-on type; blue www.wago.com/793-501/000-006



Item no.: 793-501/000-005
WMB marking card; as card; not stretchable; plain; snap-on type; red www.wago.com/793-501/000-005



Item no.: 793-501
WMB marking card; as card; not stretchable; plain; snap-on type; white www.wago.com/793-501



Item no.: 793-501/000-024
WMB marking card; as card; not stretchable; plain; snap-on type; violet www.wago.com/793-501/000-024

Subject to changes. Please also observe the further product documentation!



Item no.: 793-5501/000-005

WMB marking card; as card; for terminal block width 5 - 17.5 mm; stretchable 5 - 5.2 mm; plain; snap-on type; red www.wago.com/793-5501/000-005



Item no.: 793-5501/000-002

WMB marking card; as card; for terminal block width 5 - 17.5 mm; stretchable 5 - 5.2 mm; plain; snap-on type; yellow www.wago.com/793-5501/000-002



Item no.: 793-5501/000-006

WMB marking card; as card; for terminal block width 5 - 17.5 mm; stretchable 5 - 5.2 mm; plain; snap-on type; blue www.wago.com/793-5501/000-006



Item no.: 793-5501

WMB marking card; as card; for terminal block width 5 - 17.5 mm; stretchable 5 - 5.2 mm; plain; snap-on type; white www.wago.com/793-5501



Item no.: 2009-115/000-012

WMB-Inline; for Smart Printer; 1500 pieces on roll; stretchable 5 - 5.2 mm; plain; snap-on type; orange www.wago.com/2009-115/000-012



Item no.: 2009-115/000-006

WMB-Inline; for Smart Printer; 1500 pieces on roll; stretchable 5 - 5.2 mm; plain; snap-on type; blue www.wago.com/2009-115/000-006

Downloads

Documentation

Additional Information

| | | | |
|------------------------|------------|--------|----------|
| Technical Section | 2019 Apr 3 | pdf | Download |
| Technical explanations | | 2.0 MB | |

CAD/CAE-Data

CAD data

| | | |
|----------------------|-----|----------|
| 2D/3D Models 745-841 | URL | Download |
|----------------------|-----|----------|

CAE data

| | | |
|---------------------------|-----|----------|
| EPLAN Data Portal 745-841 | URL | Download |
|---------------------------|-----|----------|

| | | |
|----------------------|-----|----------|
| ZUKEN Portal 745-841 | URL | Download |
|----------------------|-----|----------|

PCB Design

Subject to changes. Please also observe the further product documentation!



[URL](#)

[Download](#)

Symbol and Footprint 745-841

CAX data for your PCB design, consisting of "schematic symbols and PCB footprints", allow easy integration of the WAGO component into your development environment.

Supported formats:

- Accel EDA 14 & 15
- Altium 6 to current version
- Cadence Allegro
- DesignSpark
- Eagle Libraries
- KiCad
- Mentor Graphics BoardStation
- Mentor Graphics Design Architect
- Mentor Graphics Design Expedition 99 and 2000
- OrCAD 9.X PCB and Capture
- PADS PowerPCB 3, 3.5, 4.X, and 5.X
- PADS PowerPCB and PowerLogic 3.0
- PCAD 2000, 2001, 2002, 2004, and 2006
- Pulsonix 8.5 or newer
- STL
- 3D STEP
- TARGET 3001!
- View Logic ViewDraw
- Quadcept
- Zuken CadStar 3 and 4
- Zuken CR-5000 and CR-8000

PCB Component Libraries (EDA), PCB CAD Library Ultra Librarian

Environmental Product Compliance

Compliance Search

Environmental Product Compliance 745-841

[URL](#)

[Download](#)

Stackable PCB terminal block; 6 mm²; Pin spacing 10 mm; 1-pole; CAGE CLAMP®; commoning option; 6,00 mm²; gray

Subject to changes. Please also observe the further product documentation!

Installation Notes

Conductor termination

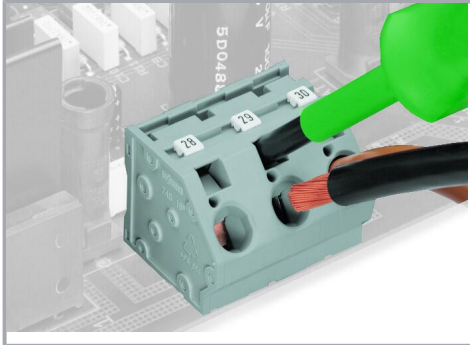

Inserting/removing a conductor via 5.5 mm screwdriver – 745 Series, 16 mm².

Marking

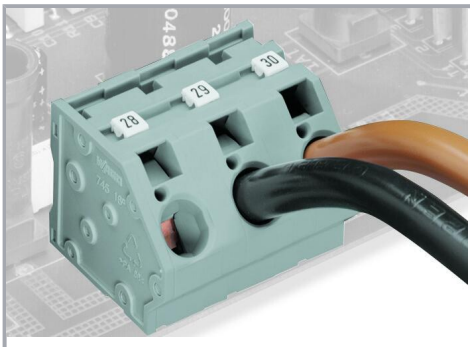

Marking via Mini-WSB and WMB markers or factory direct marking – 745 Series.

Testing

Subject to changes. Please also observe the further product documentation!

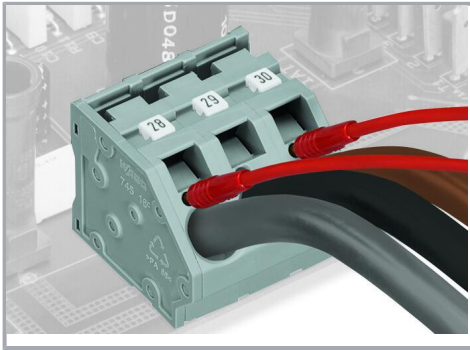

Testing with test plug – 745 Series.

Commoning

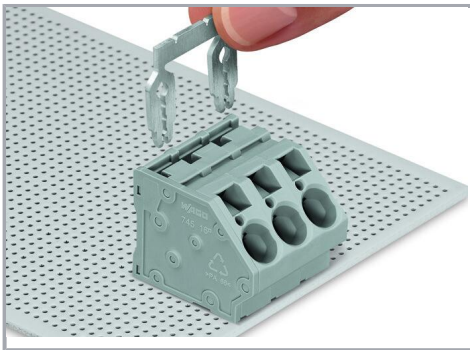

Inserting a comb-style jumper bar.

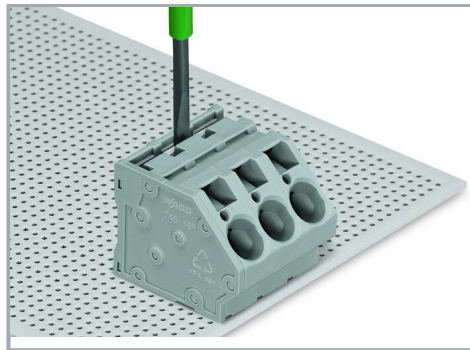

To insert a comb-style jumper bar, push it down using a screwdriver until it hits the backstop – 745 Series.

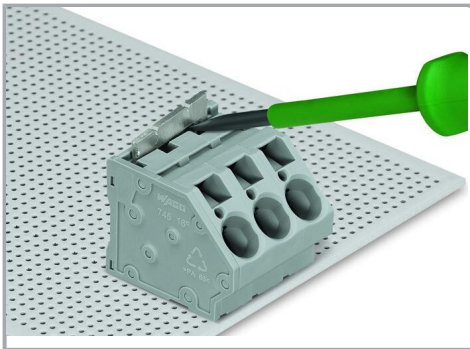

To remove the jumper bar, lift it up using a screwdriver – 745 Series.

Subject to changes. Please also observe the further product documentation!