

REV	CHANGE	DATE	DRN	CHK
	Drawn	02/27/16	SJ	T

TOLERANCE DETAILS		
1	A	±0.004 [±0.10]
2	B	+0.000 [+0.00] -0.001 [-0.03]
3	C	±0.010 [±0.30]
4	D	+0.002 [+0.05] -0.000 [-0.00]
5	E	±0.005 [±0.13]
6	F	+0.002 [+0.05] -0.000 [-0.00]

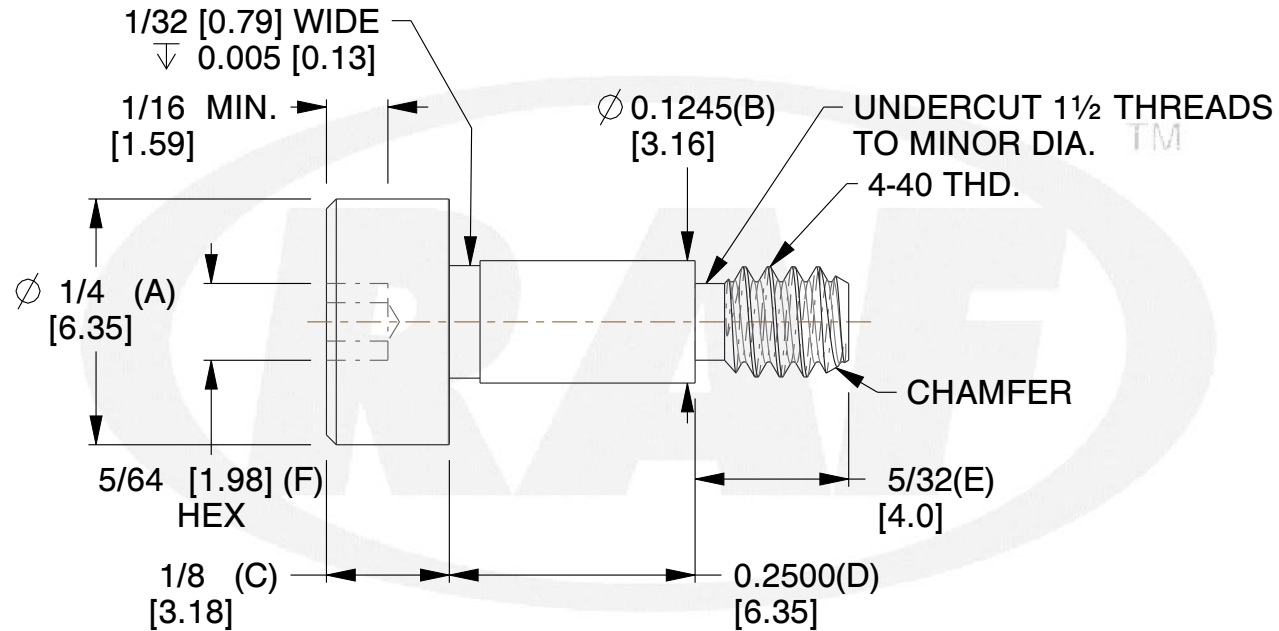

**NOTES:**

1. Material : Stainless Steel
2. Finish :
3. ASME Y14.5-M - 2009
4. All Drawing Dimensions are in Inches [mm]
5. Unless otherwise specified; Edge Breaks, Radii or Countersinks 0.005-0.015

COMPONENT	SOCKET HEAD
6903-SS	SCALE
	5.12
	SHEET
PRECISION SHOULDER SCREWS	1 of 1
SOCKET HEAD	



95 Silvermine Rd., Seymour CT 06483  
Tel: 203-888-2133, Fax: 203-888-9860

This Drawing is the Property of RAF. It contains confidential, proprietary information that is RAF property. Do not disclose to or duplicate for others except as authorized by RAF.

**TOLERANCES**  
ALL DIMENSIONS ARE INCHES (UNLESS OTHERWISE SPECIFIED)  
**METALLIC**  
LENGTHS < 6 INCHES ± 0.005  
LENGTH > 6 INCHES ± 0.010  
DIAMETERS: ± 0.005  
**NON-METALLIC**  
LENGTH: ± 0.010 DIAMETERS: ± 0.010  
**INTERNAL THREADS:**  
MINIMUM THREAD DEPTH