



RVT101HVLNWN00

IPS LVDS 10.1" LCD TFT DATASHEET

Rev.1.3
2023-01-19

ITEM	CONTENTS	UNIT
LCD Type	TFT/Transmissive/Normally Black/IPS	/
Size	10.1	Inch
Viewing Direction	Free	/
Outside Dimensions (W x H x D)	229.46 x 149.10 x 7.50	mm
Active Area (W x H)	216.96 x 135.60	mm
Pixel Pitch (W x H)	0.1695 x 0.1695	mm
Resolution	1280 x 800 (RGB)	/
Brightness	1000	cd/m ²
Color Depth	16.7 M	/
Pixel Arrangement	RGB Vertical Stripe	/
LCD Driver	EK79202B	/
Interface	LVDS	/
With/Without Touch	Without Touch Panel	/
Weight	260	g

Note 1. RoHS3 compliant

Note 2. LCM weight tolerance: $\pm 5\%$.



1. REVISION RECORD

REV NO.	REV DATE	CONTENTS	REMARKS																								
1.0	2020-10-22	Initial Release																									
1.1	2021-05-26	Modify Electrical Specification and power on/off sequence																									
1.2	2021-07-28	Updating new template Correcting the Operating/standby current From: <table border="1" data-bbox="678 555 1236 600"> <tr> <td>Operating Current</td> <td>$I_{VDD+3.3V}$</td> <td>-</td> <td>15</td> <td>20</td> <td>mA</td> </tr> <tr> <td>Standby Current</td> <td>I_{ST}</td> <td>-</td> <td>-</td> <td>250</td> <td>uA</td> </tr> </table> To: <table border="1" data-bbox="678 633 1257 678"> <tr> <td>Operating Current</td> <td>$I_{VDD+3.3V}$</td> <td>-</td> <td>280</td> <td>420</td> <td>mA</td> </tr> <tr> <td>Standby Current</td> <td>I_{ST}</td> <td>-</td> <td>15</td> <td>2.0</td> <td>mA</td> </tr> </table>	Operating Current	$I_{VDD+3.3V}$	-	15	20	mA	Standby Current	I_{ST}	-	-	250	uA	Operating Current	$I_{VDD+3.3V}$	-	280	420	mA	Standby Current	I_{ST}	-	15	2.0	mA	
Operating Current	$I_{VDD+3.3V}$	-	15	20	mA																						
Standby Current	I_{ST}	-	-	250	uA																						
Operating Current	$I_{VDD+3.3V}$	-	280	420	mA																						
Standby Current	I_{ST}	-	15	2.0	mA																						
1.3	2023-01-19	Modify DE signal: Active High																									



2. CONTENTS

1.	REVISION RECORD.....	2
2.	CONTENTS.....	3
3.	MODULE CLASSIFICATION INFORMATION.....	4
4.	MODULE DRAWING.....	5
5.	ABSOLUTE MAXIMUM RATINGS.....	6
6.	ELECTRICAL CHARACTERISTICS.....	6
7.	BACKLIGHT ELECTRICAL CHARACTERISTICS.....	6
8.	ELECTRO-OPTICAL CHARACTERISTICS.....	7
9.	INTERFACES DESCRIPTION.....	9
9.1	TFT assignment.....	9
10.	TIMING CHARACTERISTICS.....	10
10.1	LVDS interface characteristic.....	10
10.2	Timing table.....	10
10.3	Power ON/OFF sequence.....	11
10.3.1	Power on sequence.....	11
10.3.2	Power off sequence.....	11
11.	INSPECTION.....	12
11.1	Inspection condition.....	12
11.2	Inspection standard.....	13
12.	RELIABILITY TEST.....	14
13.	LEGAL INFORMATION.....	15



3. MODULE CLASSIFICATION INFORMATION

RV	T	101	H	V	L	N	W	N	00
1.	2.	3.	4.	5.	6.	7.	8.	9.	10.

NO.	PARAMETER	SYMBOL
1.	BRAND	RV – Riverdi
2.	PRODUCT TYPE	T – TFT Standard
3.	DISPLAY SIZE	101 – 10.1"
4.	MODEL SERIAL NO.	H – High Brightness, IPS
5.	RESOLUTION	V – 1280 x 800 px
6.	INTERFACE	L – TFT LCD, LVDS
7.	FRAME	N – Without Mounting Metal Frame
8.	BACKLIGHT TYPE	W – LED White
9.	TOUCH PANEL	N – Without Touch Panel
10.	VERSION	00 – (00-99)

Revision:	Changes:	Date:
1.0	Initial Case	2020.09.08
1.1	Dimensions Overhaul	2021.06.23

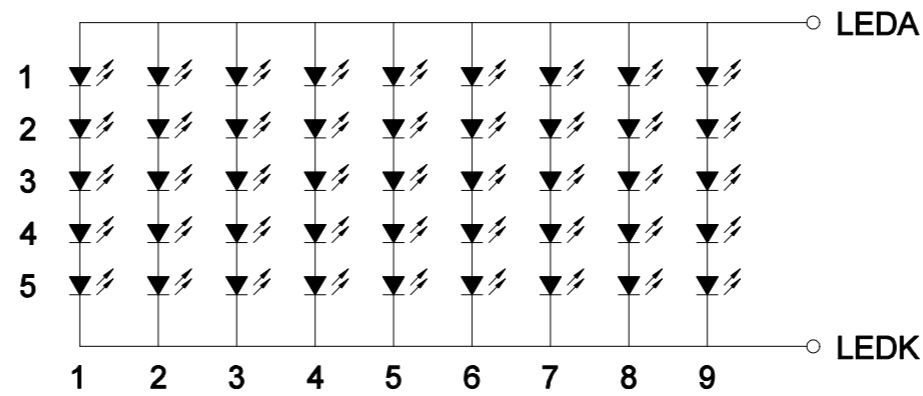
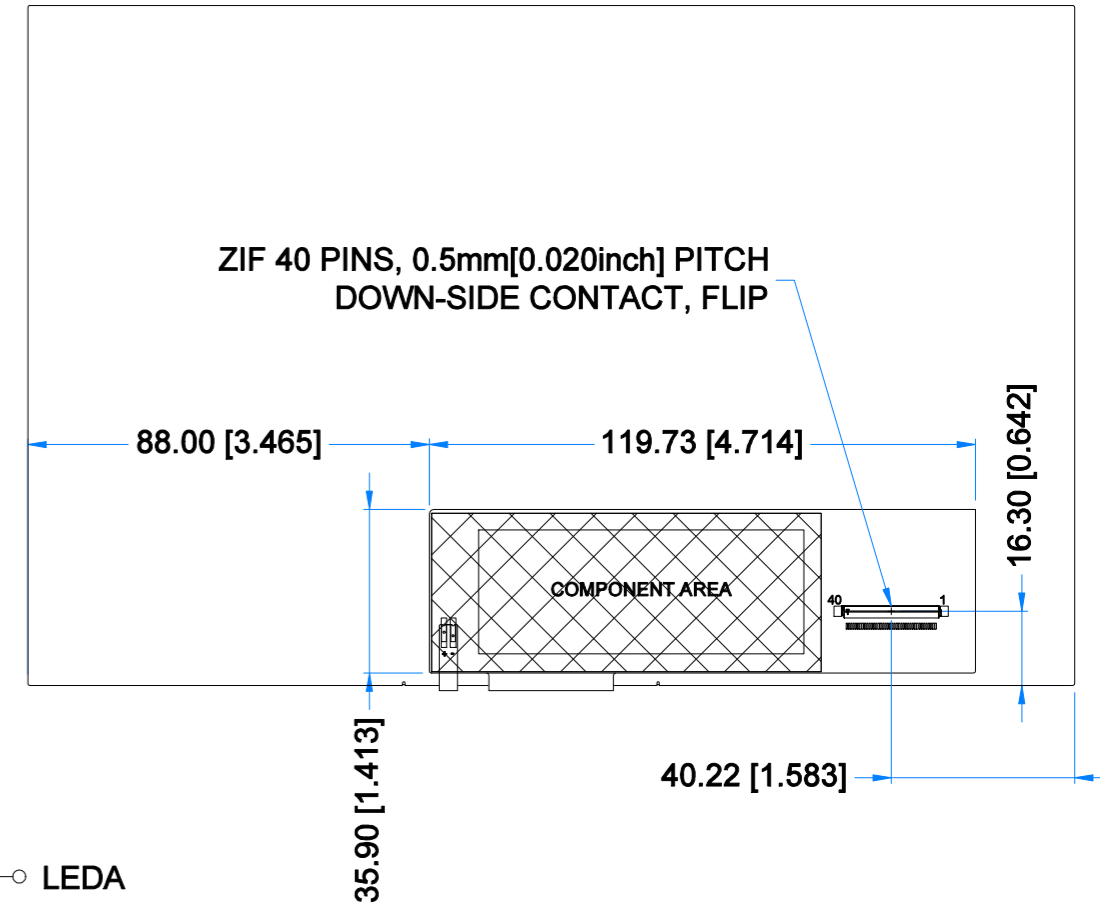
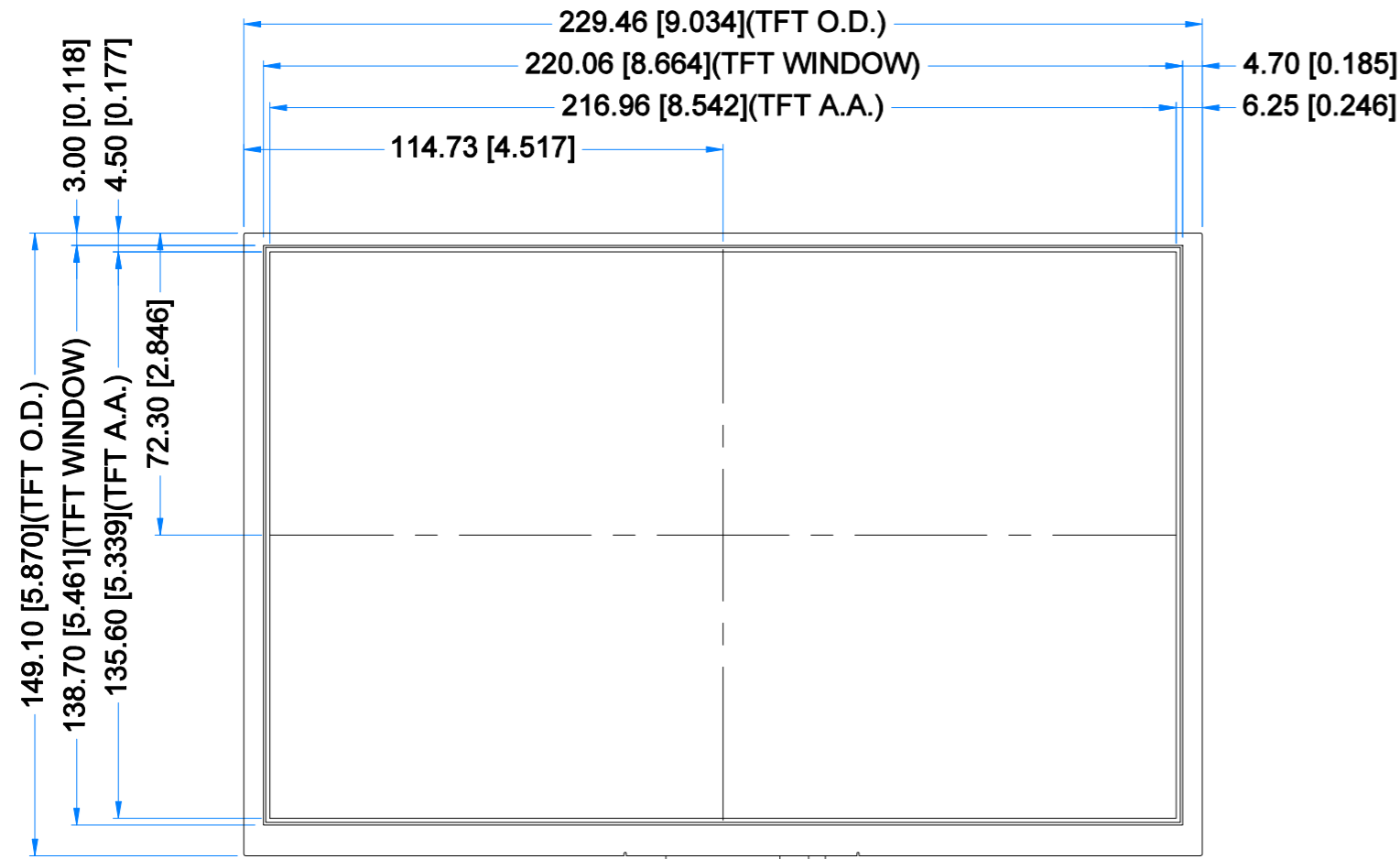

LED Diagram Circuit

TFT NOTES:

- LCD TYPE: TRANSMISSIVE, NORMALLY BLACK, IPS
- RESOLUTION: 1280x800
- VIEWING ANGLE: FREE
- DRIVING VOLTAGE: 3.3V
- SURFACE LUMINANCE: 1000cd/m²
- BACKLIGHT: 45 LEDS, V_F=16.0V(TYP.), I_F=360mA
- ZERO BAD PIXEL

GENERAL NOTES:

- OPERATING TEMPERATURE: -20°C ~ 70°C
- STORAGE TEMPERATURE: -30°C ~ 80°C
- WITHOUT INDIVIDUAL TOLERANCE:
±0.3mm[0.012inch]
- RoHS COMPLIANT

PN: RVT101HVLNWN00

SN:

DRAWN: M.Natywa

2021.06.23

1:1.66

CHECKED: K.Brodacka

2021.07.07

[mm]

APPR:

ISO A3

P. 1 of 1

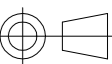



5. ABSOLUTE MAXIMUM RATINGS

PARAMETER	SYMBOL	MIN	MAX	UNIT
Supply Voltage for Module	VDD	-0.3	3.9	V
Operating Temperature	T _{OP}	-20	70	°C
Storage Temperature	T _{ST}	-30	80	

Note 1. The absolute maximum rating values must not be exceeded at any times. The module MUST NOT be used when any of the absolute maximum ratings is exceeded.

The characteristics of the module may not be recovered, or in an extreme case, the module may be permanently destroyed.

6. ELECTRICAL CHARACTERISTICS

PARAMETER	SYMBOL	MIN	TYP	MAX	UNIT
Supply Voltage	V _{DD}	2.6	3.3	3.6	V
Operating Current	I _{VDD=3.3V}	-	280	420	mA
Standby Current	I _{ST}	-	1.5	2.0	mA

7. BACKLIGHT ELECTRICAL CHARACTERISTICS

PARAMETER	SYMBOL	MIN	TYP	MAX	UNIT	NOTE
Backlight Driving Voltage	V _F	15.0	16.0	17.0	V	
Backlight Driving Current	I _F	315	360	405	mA	
Backlight Power Consumption	W _{BL}	-	5760	-	mW	
LED Lifetime	-	-	50,000	-	hours	Note 1

Note 1. Each LED: I_F =40 mA, V_F=3.2 ±0.2V.

Note 2. Optical performance should be evaluated at T_a=25 °C only.

Note 3. Operating life means the period in which the LED brightness goes down to 50% of the initial brightness. Typical operating lifetime is the estimated parameter.

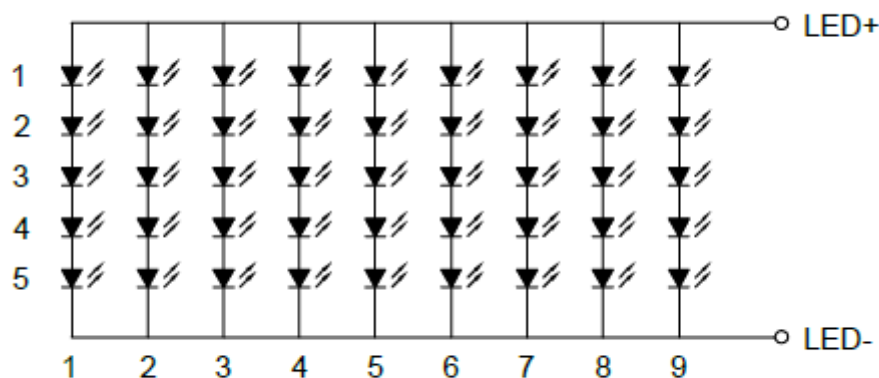

LED Diagram Circuit



8. ELECTRO-OPTICAL CHARACTERISTICS

ITEM	SYMBOL	CONDITION	MIN	TYP	MAX	UNIT	RMK	NOTE
Response Time	Tr+Tf	$\theta=0^\circ$ $\phi=0^\circ$ Ta=25 °C	-	25	35	ms	FIG 1.	4
Contrast Ratio	Cr		800	1000	-	---	FIG 2.	1
Luminance Uniformity	δ WHITE		-	75	-	%		3
Surface Luminance	Lv		-	1000	-	cd/m ²		2
Viewing Angle Range	θ	$\phi = 90^\circ$	75	85	-	deg	FIG 3.	6
		$\phi = 270^\circ$	75	85	-	deg		
		$\phi = 0^\circ$	75	85	-	deg		
		$\phi = 180^\circ$	75	85	-	deg		
CIE (x, y) Chromaticity	Rx	$\theta=0^\circ$ $\phi=0^\circ$ Ta=25 °C	0.22	0.26	0.30	-	FIG 2.	5
	Ry		0.20	0.24	0.28	-		
	Gx		0.34	0.38	0.42	-		
	Gy		0.50	0.54	0.58	-		
	Bx		0.10	0.14	0.18	-		
	By		0.09	0.13	0.17	-		
	Wx		0.28	0.32	0.36	-		
	Wy		0.29	0.33	0.37	-		

Note 1. Contrast Ratio (CR) is defined mathematically as below, for more information see Figure 2.

$$\text{Contrast Ratio} = \frac{\text{Average Surface Luminance with all white pixels (P1, P2, P3, P4, P5)}}{\text{Average Surface Luminance with all black pixels (P1, P2, P3, P4, P5)}}$$

Note 2. Surface luminance is the LCD surface from the surface with all pixels displaying white. For more information see Figure 2.

$$L_v = \text{Average Surface Luminance with all white pixels (P1, P2, P3, P4, P5)}$$

Note 3. The uniformity in surface luminance δ WHITE is determined by measuring luminance at each test position 1 through 5, and then dividing the minimum luminance of 5 points luminance by maximum luminance of 5 points luminance. For more information see Figure 2.

$$\delta \text{ WHITE} = \frac{\text{Minimum Surface Luminance with all white pixels (P1, P2, P3, P4, P5)}}{\text{Maximum Surface Luminance with all white pixels (P1, P2, P3, P4, P5)}}$$

Note 4. Response time is the time required for the display to transition from white to black (Rise Time, Tr) and from black to white (Decay Time, Tf). For additional information see Figure 1. The test equipment is BM-7A.

Note 5. CIE (x, y) chromaticity, the x, y value is determined by measuring luminance at each test position 1 through 5, and then calculating the average value.

Note 6. For TFT module the contrast ratio is greater than 10. The angles are determined for the horizontal or x axis and the vertical or y axis with respect to the z axis which is normal to LCD surface. For more information see Figure 3.

Note 7. Viewing angle is measured at the center point of the LCD by CONOSCOPE (ergo-80). For response time testing, the testing data is based on BM-7A. Instruments for Contrast Ratio, Surface Luminance, Luminance Uniformity, Chromaticity the test data is based on SR-3A.

Figure 1. The definition of response time

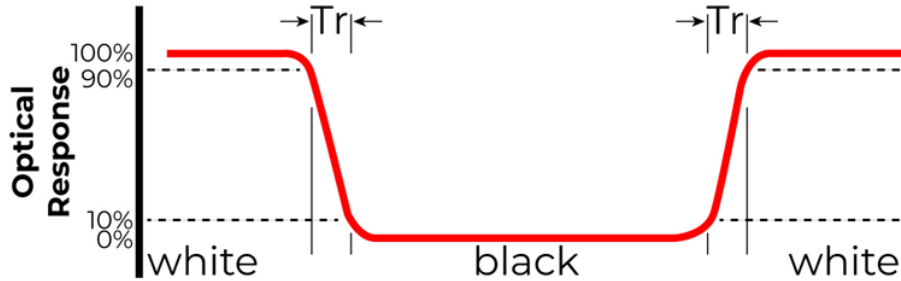

Figure 2. Measuring method for Contrast ratio, surface luminance, Luminance uniformity, CIE (x, y) chromaticity

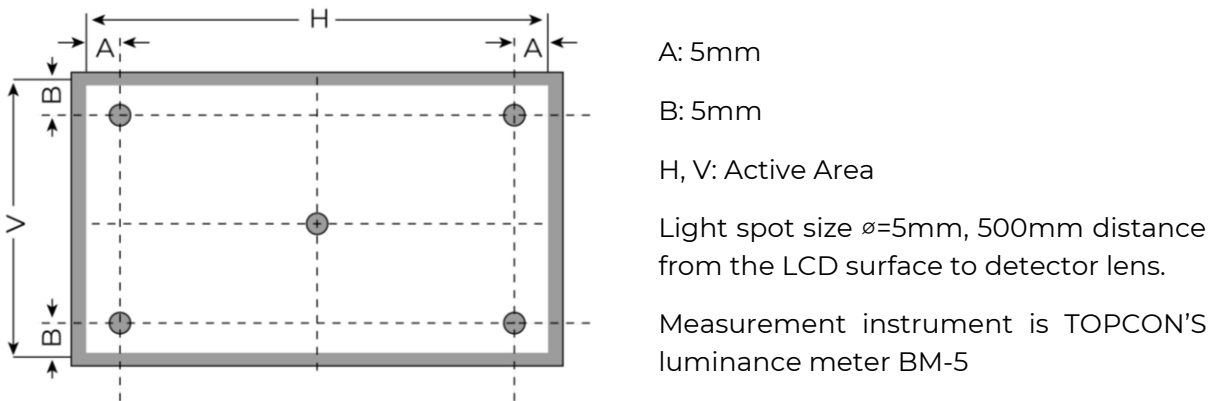
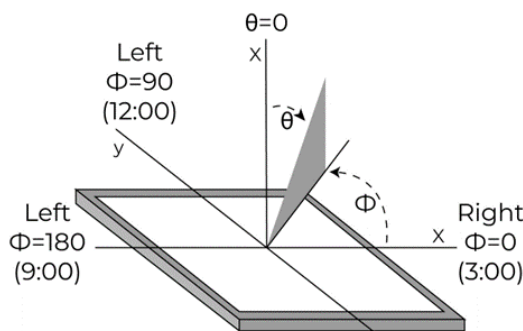

Figure 3. The definition of viewing angle





9. INTERFACES DESCRIPTION

9.1 TFT assignment

Matched Riverdi ZIF connector: ZIF0540DH-CF25

PIN NO.	SYMBOL	I/O	DESCRIPTION
1	NC	-	No Connection
2	V _{DD}	P	Power Supply, 3.3V
3	V _{DD}	P	Power Supply, 3.3V
4-6	NC	-	No Connection
7	GND	P	Ground
8	Rxin0-	I	-LVDS Differential Data Input
9	Rxin0+	I	+LVDS Differential Data Input
10	GND	P	Ground
11	Rxin1-	I	-LVDS Differential Data Input
12	Rxin1+	I	+LVDS Differential Data Input
13	GND	P	Ground
14	Rxin2-	I	-LVDS Differential Data Input
15	Rxin2+	I	+LVDS Differential Data Input
16	GND	P	Ground
17	RxCLK-	I	-LVDS Differential Data Input
18	RxCLK+	I	+LVDS Differential Data Input
19	GND	P	Ground
20	Rxin3-	I	-LVDS Differential Data Input
21	Rxin3+	I	+LVDS Differential Data Input
22	GND	P	Ground
23	NC	-	No Connection
24	NC	-	No Connection
25	GND	P	Ground
26-29	NC	-	No Connection
30	GND	P	Ground
31	LED-	P	LED Cathode
32	LED-	P	LED Cathode
33	NC	-	No Connection
34	NC	-	No Connection
35	NC	-	No Connection
36	NC	-	No Connection
37	NC	-	No Connection
38	NC	-	No Connection
39	LED+	P	LED Anode
40	LED+	P	LED Anode

Note 1. I: input, P:Power



10. TIMING CHARACTERISTICS

10.1 LVDS interface characteristic

VESA Format: 8-bit LVDS input, (LVBIT=H, LVFMT=H)

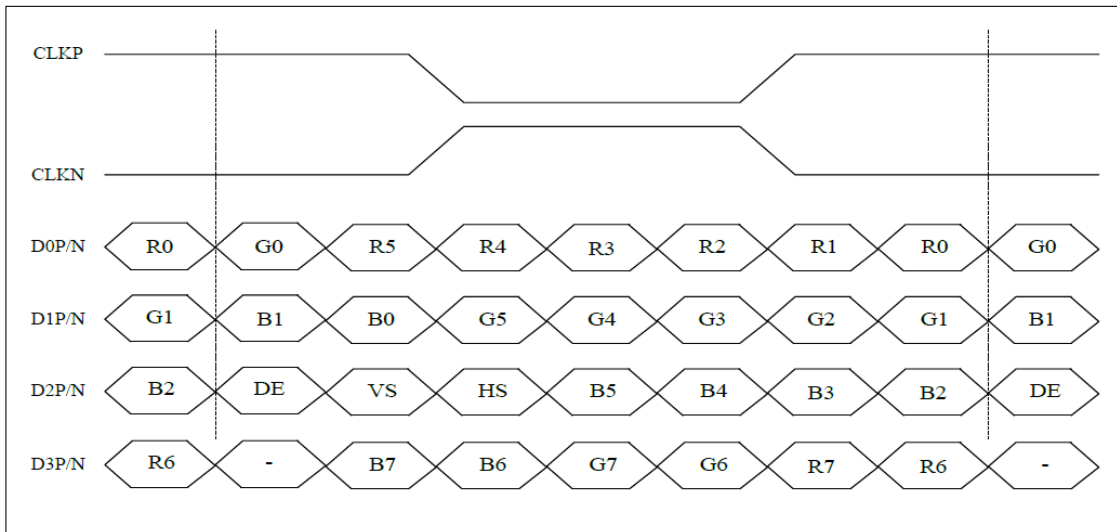

Note 1: Control signals DE: Active High VS HS: Active Low

10.2 Timing table

PARAMETER	SYMBOL	MIN	TYP	MAX	UNIT
Clock Frequency (Rate=60Hz (LVDS))	FDCLK	66.3	72.4	78.9	MHz
HSYNC Period Time	T_H	1380	1440	1500	DCLK
Horizontal Display area	T_{HD}	1280			DCLK
Hsync pulse Width	T_{HPW}	1	-	40	Tc
Hsync Back Porch (With pulse width)	T_{HBP}	88	88	88	DCLK
Hsync Front Porch	T_{HFP}	12	72	132	DCLK
VSYNC Period Time	T_V	824	838	872	H
Vertical Display area	T_{VD}	800			
Vsync pulse Width	T_{VW}	1	-	20	
Vsync Back Porch (With pulse width)	T_{VBP}	23	23	23	
Vsync Front Porch	T_{VFP}	1	15	49	



10.3 Power ON/OFF sequence

10.3.1 Power on sequence

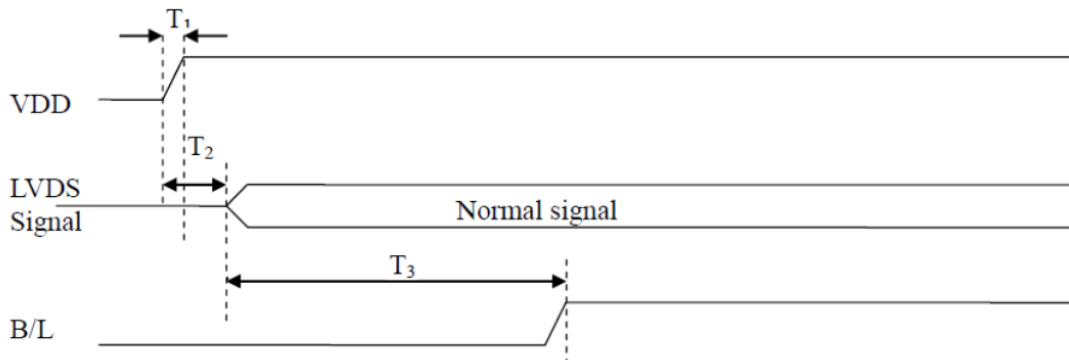

PARAMETER	VALUE			UNIT
	MIN.	TYP.	MAX.	
T1	0.5	2	10	ms
T2	0	5	50	
T3	130	136	210	

10.3.2 Power off sequence

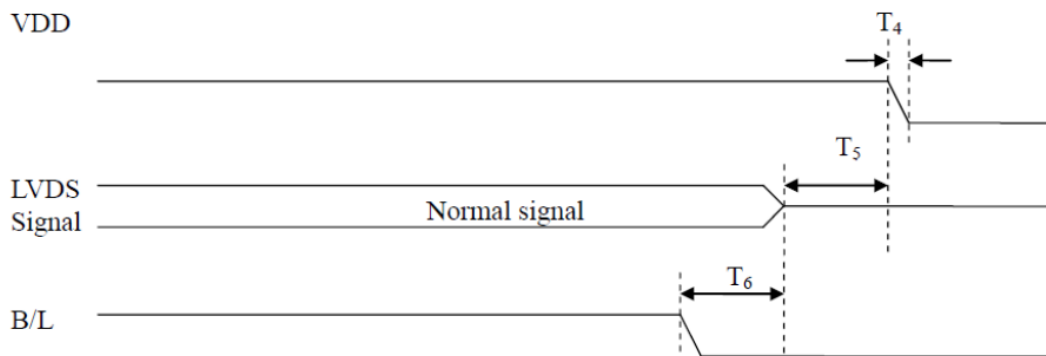

PARAMETER	VALUE			UNIT
	MIN.	TYP.	MAX.	
T4	0.5	2	10	ms
T5	0	7	50	
T6	0	2	100	

11. INSPECTION

Standard acceptance/rejection criteria for TFT module

11.1 Inspection condition

Ambient conditions:

- Temperature: $25 \pm 2^{\circ}\text{C}$
- Humidity: $(60 \pm 10) \%RH$
- Illumination: Single fluorescent lamp non-directive (300 to 700 lux)

Viewing distance: $35 \pm 5\text{cm}$ between inspector bare eye and LCD.

Viewing Angle: U/D: $45^{\circ}/45^{\circ}$, L/R: $45^{\circ}/45^{\circ}$

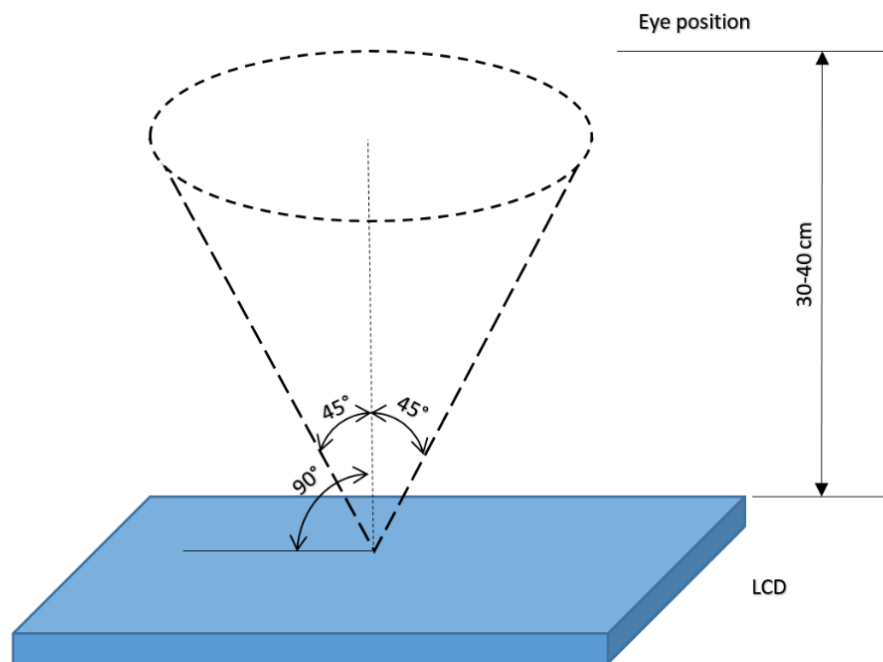



11.2 Inspection standard

The LCD TFT has zero bad pixels. Please refer the item “Bright/Dark dots”.

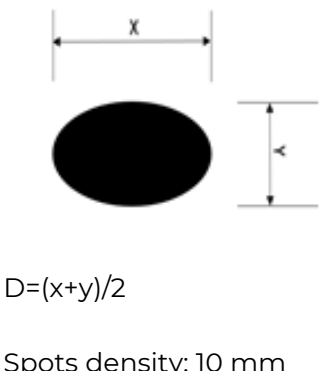
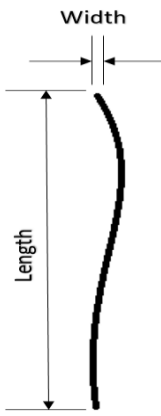
ITEM		CRITERION		
Black spots, white spots, light leakage, Foreign Particle (round Type)	 <p>$D=(x+y)/2$</p> <p>Spots density: 10 mm</p>	Size = 10.1"		
		Average Diameter	Qualified Qty	
		$D \leq 0.2 \text{ mm}$	Ignored	
		$0.2 \text{ mm} < D \leq 0.3 \text{ mm}$	$N \leq 4$	
		$0.5 \text{ mm} < D$	Not allowed	
LCD black spots, white spots, light leakage (line Type)	 <p>Spots density: 10 mm</p>	Size = 10.1"		
		Length	Width	Qualified Qty
		-	$W \leq 0.05$	Ignored
		$L \leq 5.0$	$0.05 < W \leq 0.1$	$N \leq 3$
		$5.0 < L$	$0.10 < W$ $5.0 < L$	Not allowed
Bright/Dark Dots	Size = 10.1			
	Item	Qualified Qty		
	Bright dots	0		
	Dark dots	0		
	Cluster Bright Dots or Dark Dots	0		
Total Bright and Dark Dots		0		
Clear spots	Size ≥ 5.0 "			
	Average Diameter	Qualified Qty		
	$D < 0.2 \text{ mm}$	Ignored		
	$0.2 \text{ mm} < D < 0.3 \text{ mm}$	4		
	$0.3 \text{ mm} < D < 0.5 \text{ mm}$	2		
	$0.5 \text{ mm} < D$	0		
Spots density: 10 mm				



12. RELIABILITY TEST

NO.	TEST ITEM	TEST CONDITION	NOTE
1	High Temperature Storage	80°C/120 hours	Note 1
2	Low Temperature Storage	-30°C/120 hours	
3	High Temperature Operating	70 °C /120 hours	
4	Low Temperature Operating	-20°C/120 hours	
5	High Temperature and High Humidity	Humidity 40°C, 90%RH, 120Hrs	
6	Thermal Cycling Test (No operation)	-20°C for 30min, 70°C for 30 min. 100 cycles. Then test at room temperature after 1 hour	Note 2
7	Vibration Test	Frequency: 10 ÷ 55 Hz. Stroke: 1.5 mm. Sweep: 10Hz ÷ 55Hz ÷ 10 Hz. 2 hours for each direction of X, Y, Z (Total 6 hours)	
8	Package Drop Test	Height: 60 cm 1 corner, 3 edges, 6 surfaces	

Note 1. Sample quantity for each test item is 5 ÷ 10 pcs.

Note 2. Before cosmetic and function test, the product must have enough recovery time, at least 2 hours at room temperature.



13. LEGAL INFORMATION

CE marking is usually obligatory only for a complete end product. Riverdi display modules are semi-finished goods which are used as inputs to become part of the finished products.

Therefore, Riverdi display modules are not CE marked.

Riverdi grants the guarantee for the proper operation of the goods for a period of 12 months from the date of possession of the goods. If in a consequence of this guaranteed execution the customer has received the defects-free item as replacement for the defective item, the effectiveness period of this guarantee shall start anew from the moment the customer receives the defects-free item.

Information about device is the property of Riverdi and may be the subject of patents pending or granted. It is not allowed to copy or disclosed this document without prior written permission.

Riverdi endeavors to ensure that all contained information in this document is correct but does not accept liability for any error or omission. Riverdi products are in developing process and published information may be not up to date. Riverdi reserves the right to update and makes changes to Specifications or written material without prior notice at any time. It is important to check the current position with Riverdi.

Images and graphics used in this document are only for illustrative the purpose. All images and graphics are possible to be displayed on the range products of Riverdi, however the quality may vary. Riverdi is no liable to the buyer or to any third party for any indirect, incidental, special, consequential, punitive or exemplary damages (including without limitation lost profits, lost savings, or loss of business opportunity) relating to any product, service provided or to be provided by Riverdi, or the use or inability to use the same, even if Riverdi has been advised of the possibility of such damages.

Riverdi products are not fault tolerant nor designed, manufactured or intended for use or resale as on line control equipment in hazardous environments requiring fail-safe performance, such as in the operation of nuclear facilities, aircraft navigation or communication systems, air traffic control, direct life support machines or weapons systems in which the failure of the product could lead directly to death, personal injury or severe physical or environmental damage ('High-Risk Activities'). Riverdi and its suppliers specifically disclaim any expressed or implied warranty of fitness for High-Risk Activities. Using Riverdi products and devices in 'High-Risk Activities' and in any other application is entirely at the buyer's risk, and the buyer agrees to defend, indemnify and hold harmless Riverdi from all damages, claims or expenses resulting from such use. No licenses are conveyed, implicitly or otherwise, under any Riverdi intellectual property rights.



Hi, I am here to help you!
If you have any additional questions, please contact our support via email:
contact@riverdi.com

