

## Data sheet | Item number: 282-821

2-conductor disconnect/test terminal block; longitudinal switching; with touch-proof test sockets; for 4 mm Ø test plugs; for DIN-rail 35 x 15 and 35 x 7.5; 6 mm<sup>2</sup>; CAGE CLAMP®; 6,00 mm<sup>2</sup>; gray

[www.wago.com/282-821](http://www.wago.com/282-821)

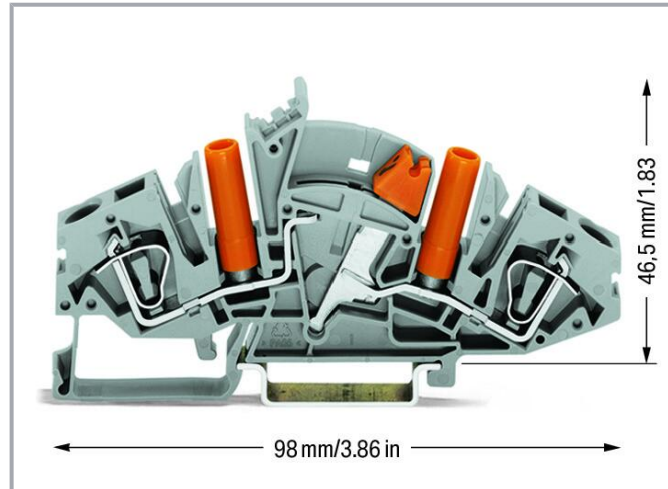
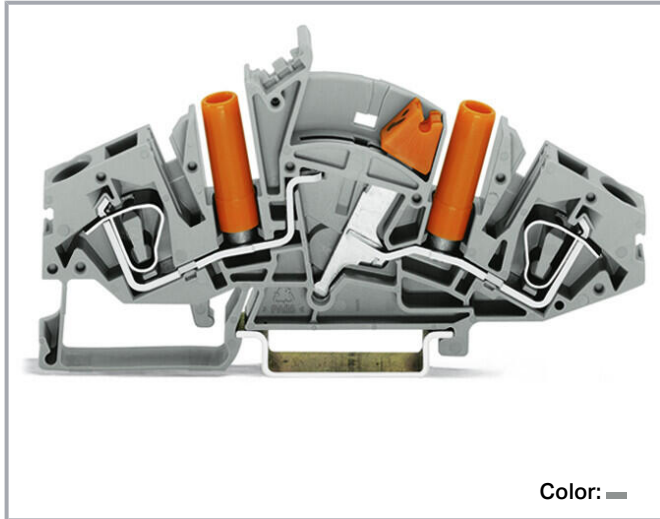

## Data

### Electrical data

### Ratings per IEC/EN

Nominal voltage (III/3)	500 V
Rated impulse voltage (III/3)	6 kV
Rated current	30 A
Legend (ratings)	(III / 3) ≙ Overvoltage category III / Pollution degree 3

### Power loss

Power loss, per pole (potential)	0.702 W
Rated current $I_N$ for specified power loss	30 A
Resistance value for specified, current-dependent power loss	0.001 Ω

### Connection data

Connection points	2
Total number of potentials	2
Number of levels	1

Subject to changes. Please also observe the further product documentation!

WAGO GmbH & Co. KG  
Hansastr. 27  
32423 Minden  
Phone: +49571 887-0 | Fax: +49571 887-169  
Email: [info.de@wago.com](mailto:info.de@wago.com) | Web: [www.wago.com](http://www.wago.com)

Do you have any questions about our products?  
We are always happy to take your call at +49 (571) 887-44222.



## Connection 1

Connection technology	CAGE CLAMP®
Actuation type	Operating tool
Connectable conductor materials	Copper
Solid conductor	0.2 ... 6 mm <sup>2</sup> / 24 ... 10 AWG
Fine-stranded conductor	0.2 ... 6 mm <sup>2</sup> / 24 ... 10 AWG
Strip length	12 ... 13 mm / 0.47 ... 0.51 inches
Wiring direction	Front-entry wiring

## Physical data

Width	8 mm / 0.315 inches
Height	98 mm / 3.858 inches
Depth from upper-edge of DIN-rail	46.5 mm / 1.831 inches

## Mechanical Data

Design	angled
Mounting type	DIN-35 rail
Marking level	Center/side marking

## Material Data

Note (material data)	Information on material specifications can be found here
Color	gray
Material group	I
Insulation material	Polyamide (PA66)
Flammability class per UL94	V0
Fire load	0.349 MJ
Weight	24.8 g

## Environmental requirements

Processing temperature	-35 ... +85 °C
Continuous operating temperature	-60 ... +105 °C

Subject to changes. Please also observe the further product documentation!

## Commercial data



Product Group	1 (Rail Mounted Terminal Blocks)
eCl@ss 10.0	27-14-11-26
eCl@ss 9.0	27-14-11-26
ETIM 8.0	EC000902
ETIM 7.0	EC000902
PU (SPU)	20 pcs
Packaging type	box
Country of origin	CN
GTIN	4050821227526
Customs tariff number	85365080900

## Environmental Product Compliance

RoHS Compliance Status	Compliant, No Exemption
------------------------	-------------------------

## Approvals / Certificates

### General approvals

Logo	Approval	Additional Approval Text	Certificate name
	CCA DEKRA Certification B.V.	EN 60947	NTR NL 7894
	cURus Underwriters Laboratories Inc.	UL 1059	E45172
	KEMA/KEUR DEKRA Certification B.V.	EN 60947	71- 120778

### Declarations of conformity and manufacturer's declarations

Logo	Approval	Additional Approval Text	Certificate name
	EU-Declaration of Conformity WAGO GmbH & Co. KG	-	-

Subject to changes. Please also observe the further product documentation!



WAGO GmbH & Co. KG  
Hansastr. 27  
32423 Minden  
Phone: +49571 887-0 | Fax: +49571 887-169  
Email: [info.de@wago.com](mailto:info.de@wago.com) | Web: [www.wago.com](http://www.wago.com)

Do you have any questions about our products?  
We are always happy to take your call at +49 (571) 887-44222.





UK-Declaration of Conformity  
WAGO GmbH & Co. KG

### Approvals for marine applications

Logo	Approval	Additional Approval Text	Certificate name
	<b>ABS</b> American Bureau of Shipping	EN 60947	20- HG1941090- PDA
	<b>DNV GL</b> Det Norske Veritas, Germanischer Lloyd	-	TAE00001V2



### Required accessories

#### End plate

End plate		
	<b>Item no.: 282-360</b> End and separator plate; for 2-conductor longitudinal switching disconnect terminal block; 1.5 mm thick; gray	<a href="http://www.wago.com/282-360">www.wago.com/282-360</a>
	<b>Item no.: 282-365</b> End and separator plate; for 2-conductor longitudinal switching disconnect terminal block; 1.5 mm thick; orange	<a href="http://www.wago.com/282-365">www.wago.com/282-365</a>

### Optional accessories

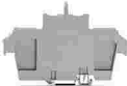
#### Mounting

Cover carrier		
	<b>Item no.: 709-168</b> Cover carrier; Type 2; incl. fixing/retaining screws and knurled nut; suitable for 283 to 285 Series rail-mounted terminal blocks; suitable for 279 to 281 Series double- and triple-deck terminal blocks; suitable for 780 to 785, 775, 776 and 777 Series TOPJOB® rail-mounted terminal blocks; suitable for 280 Series sensor and actuator terminal blocks; suitable for 282 Series disconnect/test terminal blocks for transformer circuits; gray	<a href="http://www.wago.com/709-168">www.wago.com/709-168</a>
Cover		
	<b>Item no.: 709-154</b> Cover; Type 2; suitable for cover carrier, type 2; 1 m long; transparent	<a href="http://www.wago.com/709-154">www.wago.com/709-154</a>
Mounting accessories		

Subject to changes. Please also observe the further product documentation!



**Item no.: 209-106**  
Mounting carrier; for isolated mounting on DIN 35 rails; gray

[www.wago.com/209-106](http://www.wago.com/209-106)



**Item no.: 249-116**  
Screwless end stop; 6 mm wide; for DIN-rail 35 x 15 and 35 x 7.5; gray

[www.wago.com/249-116](http://www.wago.com/249-116)

**Protective warning marker**

Cover



**Item no.: 282-415**  
Protective warning marker; for 5 terminal blocks; with high-voltage symbol, black; yellow

[www.wago.com/282-415](http://www.wago.com/282-415)

**Carrier rail**

Mounting accessories



**Item no.: 210-197**  
Steel carrier rail; 35 x 15 mm; 1.5 mm thick; 2 m long; slotted; similar to EN 60715; silver-colored

[www.wago.com/210-197](http://www.wago.com/210-197)



**Item no.: 210-198**  
Copper carrier rail; 35 x 15 mm; 2.3 mm thick; 2 m long; unslotted; according to EN 60715; copper-colored

[www.wago.com/210-198](http://www.wago.com/210-198)



**Item no.: 210-504**  
Steel carrier rail; 35 x 7.5 mm; 1 mm thick; 2 m long; slotted; galvanized; according to EN 60715; silver-colored

[www.wago.com/210-504](http://www.wago.com/210-504)



**Item no.: 210-505**  
Steel carrier rail; 35 x 7.5 mm; 1 mm thick; 2 m long; unslotted; galvanized; according to EN 60715; silver-colored

[www.wago.com/210-505](http://www.wago.com/210-505)

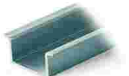

**Item no.: 210-506**  
Steel carrier rail; 35 x 15 mm; 1.5 mm thick; 2 m long; unslotted; galvanized; similar to EN 60715; silver-colored

[www.wago.com/210-506](http://www.wago.com/210-506)



**Item no.: 210-508**  
Steel carrier rail; 35 x 15 mm; 1.5 mm thick; 2 m long; slotted; galvanized; similar to EN 60715; silver-colored

[www.wago.com/210-508](http://www.wago.com/210-508)



**Item no.: 210-113**  
Steel carrier rail; 35 x 7.5 mm; 1 mm thick; 2 m long; unslotted; according to EN 60715; silver-colored

[www.wago.com/210-113](http://www.wago.com/210-113)

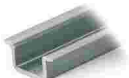

**Item no.: 210-118**  
Steel carrier rail; 35 x 15 mm; 2.3 mm thick; 2 m long; unslotted; according to EN 60715; silver-colored

[www.wago.com/210-118](http://www.wago.com/210-118)



**Item no.: 210-112**  
Steel carrier rail; 35 x 7.5 mm; 1 mm thick; 2 m long; slotted; according to EN 60715; "Hole width 25 mm; silver-colored

[www.wago.com/210-112](http://www.wago.com/210-112)



**Item no.: 210-114**  
Steel carrier rail; 35 x 15 mm; 1.5 mm thick; 2 m long; unslotted; similar to EN 60715; silver-colored

[www.wago.com/210-114](http://www.wago.com/210-114)



**Item no.: 210-115**  
Steel carrier rail; 35 x 7.5 mm; 1 mm thick; 2 m long; slotted; according to EN 60715; "Hole width 18 mm; silver-colored

[www.wago.com/210-115](http://www.wago.com/210-115)

Subject to changes. Please also observe the further product documentation!



**Item no.: 210-196**

Aluminum carrier rail; 35 x 8.2 mm; 1.6 mm thick; 2 m long; unslotted; similar to EN 60715; silver-colored [www.wago.com/210-196](http://www.wago.com/210-196)

**Jumpers**

Jumper



**Item no.: 282-437**

Jumper; 7-way; insulated; orange

[www.wago.com/282-437](http://www.wago.com/282-437)



**Item no.: 282-436/304-000**

Jumper; insulated; orange

[www.wago.com/282-436/304-000](http://www.wago.com/282-436/304-000)



**Item no.: 282-438/300-000**

Jumper; insulated; orange

[www.wago.com/282-438/300-000](http://www.wago.com/282-438/300-000)



**Item no.: 282-436/301-000**

Jumper; insulated; orange

[www.wago.com/282-436/301-000](http://www.wago.com/282-436/301-000)



**Item no.: 282-438/301-000**

Jumper; insulated; orange

[www.wago.com/282-438/301-000](http://www.wago.com/282-438/301-000)



**Item no.: 282-439**

Jumper; 9-way; insulated; orange

[www.wago.com/282-439](http://www.wago.com/282-439)



**Item no.: 282-438**

Jumper; 8-way; insulated; orange

[www.wago.com/282-438](http://www.wago.com/282-438)



**Item no.: 282-437/011-000**

Jumper; insulated; orange

[www.wago.com/282-437/011-000](http://www.wago.com/282-437/011-000)



**Item no.: 282-437/012-000**

Jumper; insulated; orange

[www.wago.com/282-437/012-000](http://www.wago.com/282-437/012-000)



**Item no.: 282-439/011-000**

Jumper; insulated; orange

[www.wago.com/282-439/011-000](http://www.wago.com/282-439/011-000)



**Item no.: 282-440**

Jumper; 10-way; insulated; orange

[www.wago.com/282-440](http://www.wago.com/282-440)



**Item no.: 282-432/100-000**

Jumper; 2-way; insulated; orange

[www.wago.com/282-432/100-000](http://www.wago.com/282-432/100-000)



**Item no.: 282-433/100-000**

Jumper; 3-way; insulated; orange

[www.wago.com/282-433/100-000](http://www.wago.com/282-433/100-000)

Subject to changes. Please also observe the further product documentation!

WAGO GmbH & Co. KG

Hansastr. 27









32423 Minden

Phone: +49571 887-0 | Fax: +49571 887-169



Email: [info.de@wago.com](mailto:info.de@wago.com) | Web: [www.wago.com](http://www.wago.com)

Do you have any questions about our products?

We are always happy to take your call at +49 (571) 887-44222.

	<b>Item no.: 282-434</b> Jumper; 4-way; insulated; orange	<a href="http://www.wago.com/282-434">www.wago.com/282-434</a>
	<b>Item no.: 282-434/100-000</b> Jumper; 4-way; insulated; orange	<a href="http://www.wago.com/282-434/100-000">www.wago.com/282-434/100-000</a>
	<b>Item no.: 282-435/300-000</b> Jumper; insulated; orange	<a href="http://www.wago.com/282-435/300-000">www.wago.com/282-435/300-000</a>
	<b>Item no.: 282-432</b> Jumper; 2-way; insulated; orange	<a href="http://www.wago.com/282-432">www.wago.com/282-432</a>
	<b>Item no.: 282-435/301-000</b> Jumper; insulated; orange	<a href="http://www.wago.com/282-435/301-000">www.wago.com/282-435/301-000</a>
	<b>Item no.: 282-433</b> Jumper; 3-way; insulated; orange	<a href="http://www.wago.com/282-433">www.wago.com/282-433</a>
	<b>Item no.: 282-436</b> Jumper; 6-way; insulated; orange	<a href="http://www.wago.com/282-436">www.wago.com/282-436</a>
	<b>Item no.: 282-435</b> Jumper; 5-way; insulated; orange	<a href="http://www.wago.com/282-435">www.wago.com/282-435</a>
	<b>Item no.: 282-435/011-000</b> Jumper; insulated; orange	<a href="http://www.wago.com/282-435/011-000">www.wago.com/282-435/011-000</a>

**Locking levers**

Locking system		
	<b>Item no.: 282-373</b> Coupling device; mechanically locks multiple links; 3-way; yellow	<a href="http://www.wago.com/282-373">www.wago.com/282-373</a>
	<b>Item no.: 282-372</b> Coupling device; mechanically locks multiple links; 2-way; yellow	<a href="http://www.wago.com/282-372">www.wago.com/282-372</a>
	<b>Item no.: 282-374</b> Coupling device; mechanically locks multiple links; 4-way; yellow	<a href="http://www.wago.com/282-374">www.wago.com/282-374</a>

**Tool**











Operating tool		
----------------	--	--

Subject to changes. Please also observe the further product documentation!

**Item no.: 210-721**

Operating tool; Blade: 5.5 x 0.8 mm; with a partially insulated shaft; multicoloured

[www.wago.com/210-721](http://www.wago.com/210-721)

Ferrule		
	<b>Item no.: 216-263</b> Ferrule; Sleeve for 1 mm <sup>2</sup> / AWG 18; insulated; electro-tin plated; electrolytic copper; gastight crimped; acc. to DIN 46228, Part 4/09.90; red	<a href="http://www.wago.com/216-263">www.wago.com/216-263</a>
	<b>Item no.: 216-266</b> Ferrule; Sleeve for 2.5 mm <sup>2</sup> / AWG 14; insulated; electro-tin plated; electrolytic copper; gastight crimped; acc. to DIN 46228, Part 4/09.90; blue	<a href="http://www.wago.com/216-266">www.wago.com/216-266</a>
	<b>Item no.: 216-264</b> Ferrule; Sleeve for 1.5 mm <sup>2</sup> / AWG 16; insulated; electro-tin plated; electrolytic copper; gastight crimped; acc. to DIN 46228, Part 4/09.90; black	<a href="http://www.wago.com/216-264">www.wago.com/216-264</a>
	<b>Item no.: 216-262</b> Ferrule; Sleeve for 0.75 mm <sup>2</sup> / 18 AWG; insulated; electro-tin plated; electrolytic copper; gastight crimped; acc. to DIN 46228, Part 4/09.90; gray	<a href="http://www.wago.com/216-262">www.wago.com/216-262</a>
	<b>Item no.: 216-267</b> Ferrule; Sleeve for 4 mm <sup>2</sup> / AWG 12; insulated; electro-tin plated; electrolytic copper; gastight crimped; acc. to DIN 46228, Part 4/09.90; gray	<a href="http://www.wago.com/216-267">www.wago.com/216-267</a>
Coding		
Locking system		
	<b>Item no.: 282-370</b> Lock-out; for disconnect link; yellow	<a href="http://www.wago.com/282-370">www.wago.com/282-370</a>
Marking accessories		
Marker		
	<b>Item no.: 2009-115/000-002</b> WMB-Inline; for Smart Printer; 1500 pieces on roll; stretchable 5 - 5.2 mm; plain; snap-on type; yellow	<a href="http://www.wago.com/2009-115/000-002">www.wago.com/2009-115/000-002</a>
	<b>Item no.: 2009-115/000-007</b> WMB-Inline; for Smart Printer; 1500 pieces on roll; stretchable 5 - 5.2 mm; plain; snap-on type; gray	<a href="http://www.wago.com/2009-115/000-007">www.wago.com/2009-115/000-007</a>
	<b>Item no.: 2009-115/000-017</b> WMB-Inline; for Smart Printer; 1500 pieces on roll; stretchable 5 - 5.2 mm; plain; snap-on type; light green	<a href="http://www.wago.com/2009-115/000-017">www.wago.com/2009-115/000-017</a>
	<b>Item no.: 2009-115/000-023</b> WMB-Inline; for Smart Printer; 1500 pieces on roll; stretchable 5 - 5.2 mm; plain; snap-on type; green	<a href="http://www.wago.com/2009-115/000-023">www.wago.com/2009-115/000-023</a>
	<b>Item no.: 2009-115/000-024</b> WMB-Inline; for Smart Printer; 1500 pieces on roll; stretchable 5 - 5.2 mm; plain; snap-on type; violet	<a href="http://www.wago.com/2009-115/000-024">www.wago.com/2009-115/000-024</a>

Subject to changes. Please also observe the further product documentation!



**Item no.:** 2009-145/000-006

Mini-WSB Inline; for Smart Printer; 1700 pieces on roll; stretchable 5 - 5.2 mm; plain; snap-on type; blue /000-006

[www.wago.com/2009-145](http://www.wago.com/2009-145)

**Item no.:** 2009-145

Mini-WSB Inline; for Smart Printer; 1700 pieces on roll; stretchable 5 - 5.2 mm; plain; snap-on type; white

[www.wago.com/2009-145](http://www.wago.com/2009-145)

**Item no.:** 2009-145/000-002

Mini-WSB Inline; for Smart Printer; 1700 pieces on roll; stretchable 5 - 5.2 mm; plain; snap-on type; yellow

[www.wago.com/2009-145/000-002](http://www.wago.com/2009-145/000-002)

**Item no.:** 2009-145/000-007

Mini-WSB Inline; for Smart Printer; 1700 pieces on roll; stretchable 5 - 5.2 mm; plain; snap-on type; gray /000-007

[www.wago.com/2009-145](http://www.wago.com/2009-145)

**Item no.:** 2009-145/000-005

Mini-WSB Inline; for Smart Printer; 1700 pieces on roll; stretchable 5 - 5.2 mm; plain; snap-on type; red /000-005

[www.wago.com/2009-145](http://www.wago.com/2009-145)

**Item no.:** 2009-145/000-012

Mini-WSB Inline; for Smart Printer; 1700 pieces on roll; stretchable 5 - 5.2 mm; plain; snap-on type; orange

[www.wago.com/2009-145/000-012](http://www.wago.com/2009-145/000-012)

**Item no.:** 2009-145/000-023

Mini-WSB Inline; for Smart Printer; 1700 pieces on roll; stretchable 5 - 5.2 mm; plain; snap-on type; green

[www.wago.com/2009-145/000-023](http://www.wago.com/2009-145/000-023)

**Item no.:** 2009-145/000-024

Mini-WSB Inline; for Smart Printer; 1700 pieces on roll; stretchable 5 - 5.2 mm; plain; snap-on type; violet /000-024

[www.wago.com/2009-145](http://www.wago.com/2009-145)



**Item no.:** 2009-115

WMB-Inline; for Smart Printer; 1500 pieces on roll; stretchable 5 - 5.2 mm; plain; snap-on type; white

[www.wago.com/2009-115](http://www.wago.com/2009-115)



**Item no.:** 248-501/000-006

Mini-WSB marking card; as card; not stretchable; plain; snap-on type; blue

[www.wago.com/248-501/000-006](http://www.wago.com/248-501/000-006)



**Item no.:** 248-501/000-007

Mini-WSB marking card; as card; not stretchable; plain; snap-on type; gray

[www.wago.com/248-501/000-007](http://www.wago.com/248-501/000-007)



**Item no.:** 248-501/000-002

Mini-WSB marking card; as card; not stretchable; plain; snap-on type; yellow

[www.wago.com/248-501/000-002](http://www.wago.com/248-501/000-002)

Subject to changes. Please also observe the further product documentation!

WAGO GmbH & Co. KG

Hansastr. 27

32423 Minden

Phone: +49571 887-0 | Fax: +49571 887-169

Email: [info.de@wago.com](mailto:info.de@wago.com) | Web: [www.wago.com](http://www.wago.com)

Do you have any questions about our products?

We are always happy to take your call at +49 (571) 887-44222.



**Item no.: 248-501/000-012**  
Mini-WSB marking card; as card; not stretchable; plain; snap-on type; orange

[www.wago.com/248-501/000-012](http://www.wago.com/248-501/000-012)



**Item no.: 248-501**  
Mini-WSB marking card; as card; not stretchable; plain; snap-on type; white

[www.wago.com/248-501](http://www.wago.com/248-501)



**Item no.: 248-501/000-017**  
Mini-WSB marking card; as card; not stretchable; plain; snap-on type; light green

[www.wago.com/248-501/000-017](http://www.wago.com/248-501/000-017)

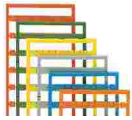

**Item no.: 248-501/000-005**  
Mini-WSB marking card; as card; not stretchable; plain; snap-on type; red

[www.wago.com/248-501/000-005](http://www.wago.com/248-501/000-005)



**Item no.: 248-501/000-024**  
Mini-WSB marking card; as card; not stretchable; plain; snap-on type; violet

[www.wago.com/248-501/000-024](http://www.wago.com/248-501/000-024)



**Item no.: 248-501/000-023**  
Mini-WSB marking card; as card; not stretchable; plain; snap-on type; green

[www.wago.com/248-501/000-023](http://www.wago.com/248-501/000-023)



**Item no.: 793-5501/000-007**  
WMB marking card; as card; for terminal block width 5 - 17.5 mm; stretchable 5 - 5.2 mm; plain; snap-on type; gray

[www.wago.com/793-5501/000-007](http://www.wago.com/793-5501/000-007)



**Item no.: 793-5501/000-012**  
WMB marking card; as card; for terminal block width 5 - 17.5 mm; stretchable 5 - 5.2 mm; plain; snap-on type; orange

[www.wago.com/793-5501/000-012](http://www.wago.com/793-5501/000-012)



**Item no.: 793-5501/000-014**  
WMB marking card; as card; for terminal block width 5 - 17.5 mm; stretchable 5 - 5.2 mm; plain; snap-on type; brown

[www.wago.com/793-5501/000-014](http://www.wago.com/793-5501/000-014)



**Item no.: 793-5501/000-017**  
WMB marking card; as card; for terminal block width 5 - 17.5 mm; stretchable 5 - 5.2 mm; plain; snap-on type; light green

[www.wago.com/793-5501/000-017](http://www.wago.com/793-5501/000-017)



**Item no.: 793-5501/000-023**  
WMB marking card; as card; for terminal block width 5 - 17.5 mm; stretchable 5 - 5.2 mm; plain; snap-on type; green

[www.wago.com/793-5501/000-023](http://www.wago.com/793-5501/000-023)

**Item no.: 793-5501/000-024**

Subject to changes. Please also observe the further product documentation!



WMB marking card; as card; for terminal block width 5 - 17.5 mm; stretchable 5 - 5.2 mm; plain; snap-on type; violet [www.wago.com/793-5501/000-024](http://www.wago.com/793-5501/000-024)



Item no.: 793-501/000-002 [www.wago.com/793-501/000-002](http://www.wago.com/793-501/000-002)  
WMB marking card; as card; not stretchable; plain; snap-on type; yellow



Item no.: 793-501/000-007 [www.wago.com/793-501/000-007](http://www.wago.com/793-501/000-007)  
WMB marking card; as card; not stretchable; plain; snap-on type; gray



Item no.: 793-501/000-017 [www.wago.com/793-501/000-017](http://www.wago.com/793-501/000-017)  
WMB marking card; as card; not stretchable; plain; snap-on type; light green



Item no.: 793-501/000-012 [www.wago.com/793-501/000-012](http://www.wago.com/793-501/000-012)  
WMB marking card; as card; not stretchable; plain; snap-on type; orange



Item no.: 793-501/000-023 [www.wago.com/793-501/000-023](http://www.wago.com/793-501/000-023)  
WMB marking card; as card; not stretchable; plain; snap-on type; green



Item no.: 793-501/000-006 [www.wago.com/793-501/000-006](http://www.wago.com/793-501/000-006)  
WMB marking card; as card; not stretchable; plain; snap-on type; blue



Item no.: 793-501/000-005 [www.wago.com/793-501/000-005](http://www.wago.com/793-501/000-005)  
WMB marking card; as card; not stretchable; plain; snap-on type; red



Item no.: 793-501 [www.wago.com/793-501](http://www.wago.com/793-501)  
WMB marking card; as card; not stretchable; plain; snap-on type; white



Item no.: 793-501/000-024 [www.wago.com/793-501/000-024](http://www.wago.com/793-501/000-024)  
WMB marking card; as card; not stretchable; plain; snap-on type; violet



Item no.: 794-5554/000-006 [www.wago.com/794-5554/000-006](http://www.wago.com/794-5554/000-006)  
WMB marking card; as card; MARKED; U/V (each 50x); stretchable 5 - 5.2 mm; Horizontal marking; snap-on type; blue

Item no.: 794-5553/000-002

Subject to changes. Please also observe the further product documentation!



WMB marking card; as card; MARKED; k/I (each 50); stretchable 5 - 5.2 mm; Horizontal marking; snap-on type; yellow

[www.wago.com/794-5553/000-002](http://www.wago.com/794-5553/000-002)



**Item no.: 793-5501/000-005**

WMB marking card; as card; for terminal block width 5 - 17.5 mm; stretchable 5 - 5.2 mm; plain; snap-on type; red

[www.wago.com/793-5501/000-005](http://www.wago.com/793-5501/000-005)



**Item no.: 793-5501/000-002**

WMB marking card; as card; for terminal block width 5 - 17.5 mm; stretchable 5 - 5.2 mm; plain; snap-on type; yellow

[www.wago.com/793-5501/000-002](http://www.wago.com/793-5501/000-002)



**Item no.: 793-5501/000-006**

WMB marking card; as card; for terminal block width 5 - 17.5 mm; stretchable 5 - 5.2 mm; plain; snap-on type; blue

[www.wago.com/793-5501/000-006](http://www.wago.com/793-5501/000-006)



**Item no.: 793-5501**

WMB marking card; as card; for terminal block width 5 - 17.5 mm; stretchable 5 - 5.2 mm; plain; snap-on type; white

[www.wago.com/793-5501](http://www.wago.com/793-5501)



**Item no.: 2009-115/000-012**

WMB-Inline; for Smart Printer; 1500 pieces on roll; stretchable 5 - 5.2 mm; plain; snap-on type; orange

[www.wago.com/2009-115/000-012](http://www.wago.com/2009-115/000-012)



**Item no.: 2009-115/000-006**

WMB-Inline; for Smart Printer; 1500 pieces on roll; stretchable 5 - 5.2 mm; plain; snap-on type; blue

[www.wago.com/2009-115/000-006](http://www.wago.com/2009-115/000-006)

## Downloads

### Documentation

#### Bid Text

282-821 X81 - Datei	2019 Feb 19	xml 3.6 kB	Download
282-821 doc - Datei	2017 Nov 6	doc 25.6 kB	Download

#### Additional Information

Technical Section Technical explanations	pdf 2.2 MB	Download
---	---------------	----------

Subject to changes. Please also observe the further product documentation!

WAGO GmbH & Co. KG  
 Hansastr. 27  
 32423 Minden  
 Phone: +49571 887-0 | Fax: +49571 887-169  
 Email: [info.de@wago.com](mailto:info.de@wago.com) | Web: [www.wago.com](http://www.wago.com)

Do you have any questions about our products?  
 We are always happy to take your call at +49 (571) 887-44222.

## CAD/CAE-Data

### CAE data

WSCAD Universe 282-821	<a href="#">URL</a>	<a href="#">Download</a>
EPLAN Data Portal 282-821	<a href="#">URL</a>	<a href="#">Download</a>

## Environmental Product Compliance

### Compliance Search

Environmental Product Compliance 282-821	<a href="#">URL</a>	<a href="#">Download</a>
2-conductor disconnect/test terminal block; longitudinal switching; with touch-proof test sockets; for 4 mm Ø test plugs; for DIN-rail 35 x 15 and 35 x 7.5; 6 mm <sup>2</sup> ; CAGE CLAMP®; 6,00 mm <sup>2</sup> ; gray		

## Installation Notes

### Conductor termination



### CAGE CLAMP® connection

Inserting a conductor.

### Commoning

Subject to changes. Please also observe the further product documentation!

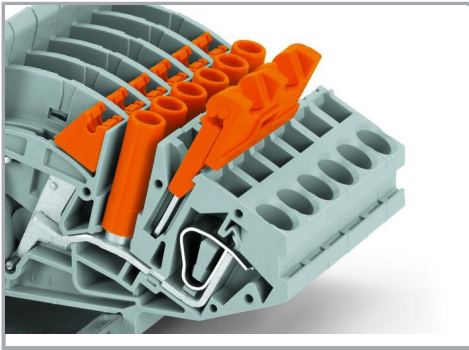

Jumper with safety lid

Jumper in pre-locked position

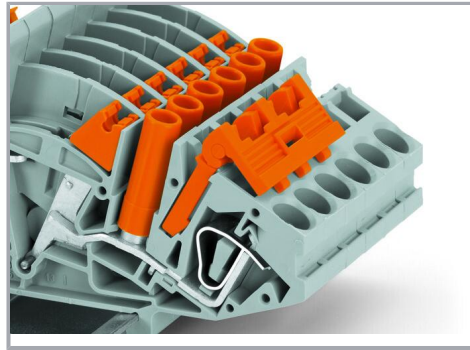

Jumper with safety lid

Longitudinal switching disconnect terminal blocks with inserted jumper, including safety lid

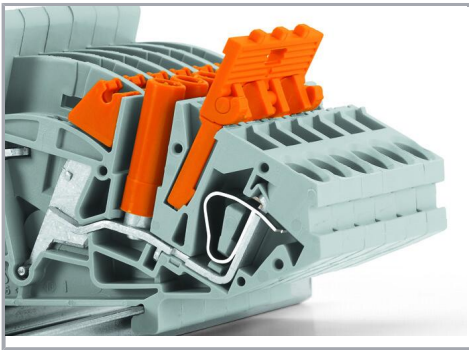

Jumper with safety lid

Jumper with raised safety lid

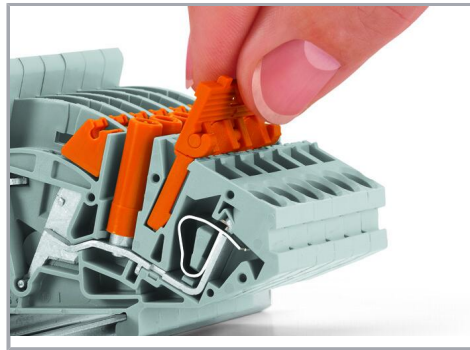

Jumper with safety lid

Removing a jumper via safety lid.

Subject to changes. Please also observe the further product documentation!



Jumper with safety lid

Remove jumper via operating tool.

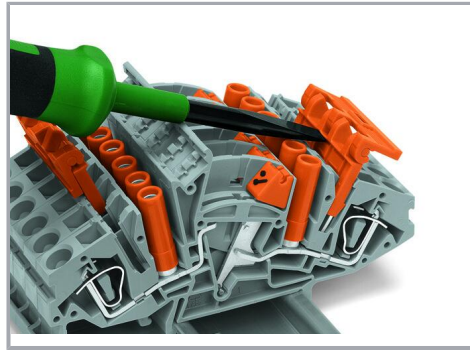

Jumper with safety lid

Remove jumper via operating tool.

### Testing

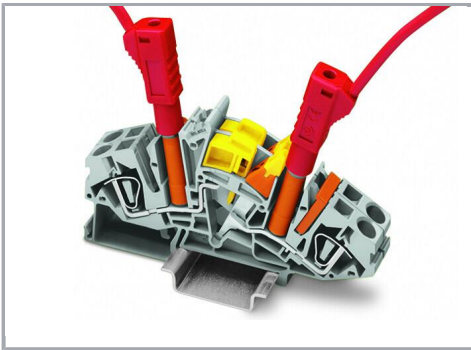

Testing via touch-proof 4 mm Ø test plugs (not available from WAGO, but offered by industry suppliers such as, Multi-Contact Deutschland GmbH).

Subject to changes. Please also observe the further product documentation!

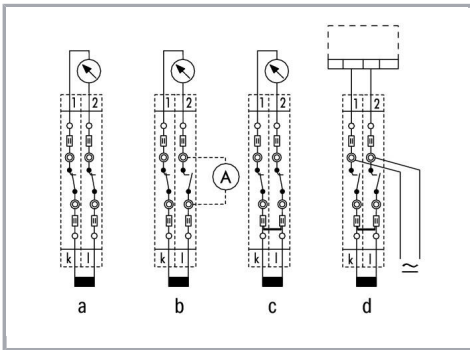

Current transformer circuit with longitudinal switching disconnect terminal blocks

a = normal operation  
b = measured value test  
c = transformer short circuit  
d = relay test

Subject to changes. Please also observe the further product documentation!