

Data sheet | Item number: 270-574

4-conductor sensor supply terminal block; Internal commoning, 9 A; with colored conductor entries; 2.5 mm²; CAGE CLAMP®; 2,50 mm²; orange

www.wago.com/270-574

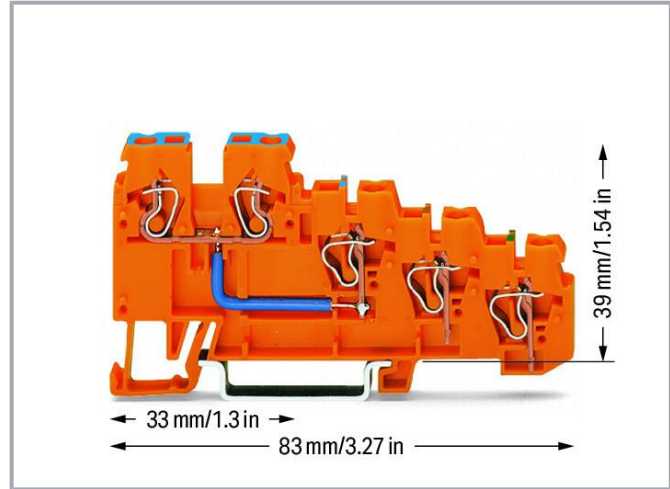
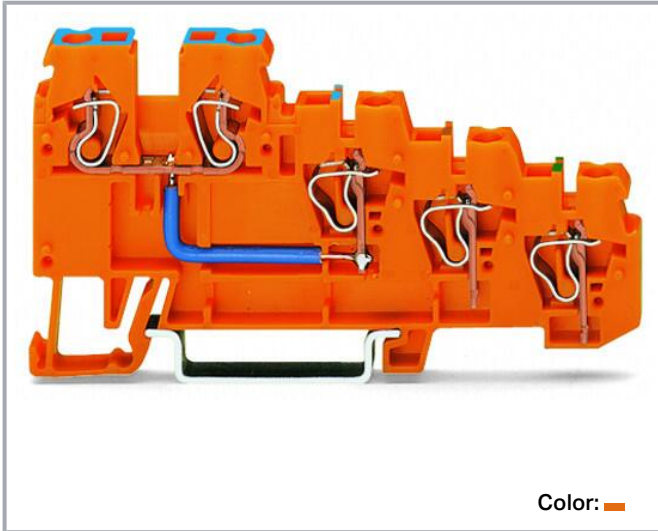

Color:

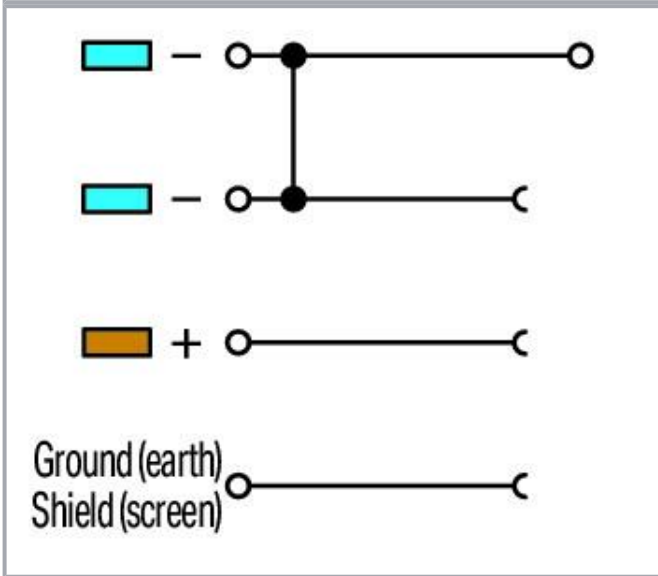

Data
Notes

Safety information

Internal bridge: 9 A

Electrical data

Subject to changes. Please also observe the further product documentation!

WAGO GmbH & Co. KG
Hansastr. 27
32423 Minden
Phone: +49571 887-0 | Fax: +49571 887-169
Email: info.de@wago.com | Web: www.wago.com

Do you have any questions about our products?
We are always happy to take your call at +49 (571) 887-44222.

Ratings per IEC/EN

Nominal voltage (III/3)	250 V
Rated impulse voltage (III/3)	4 kV
Rated current	18 A
Legend (ratings)	(III / 3) \triangleq Overvoltage category III / Pollution degree 3

Power loss

Power loss, per pole (potential)	0.431 W
Rated current I_N for specified power loss	18 A
Resistance value for specified, current-dependent power loss	0.001 Ω

Connection data

Connection points	5
Total number of potentials	3
Number of levels	4

Connection 1

Connection technology	CAGE CLAMP [®]
Actuation type	Operating tool
Connectable conductor materials	Copper
Solid conductor	0.08 ... 2.5 mm ² / 28 ... 12 AWG
Fine-stranded conductor	0.08 ... 2.5 mm ² / 28 ... 12 AWG
Note (conductor cross-section)	12 AWG: THHN, THWN
Strip length	6 ... 7 mm / 0.24 ... 0.28 inches
Wiring direction	Front-entry wiring

Physical data

Width	5 mm / 0.197 inches
Height	83 mm / 3.268 inches
Depth from upper-edge of DIN-rail	39 mm / 1.535 inches

Mechanical Data

Design	horizontal type
Mounting type	DIN-35 rail

Subject to changes. Please also observe the further product documentation!



Marking level

Side marking

Material Data

Note (material data)

Information on material specifications can be found here

Color	orange
Material group	I
Insulation material	Polyamide (PA66)
Flammability class per UL94	V0
Fire load	1.405 MJ
Weight	11 g

Environmental requirements

Processing temperature	-35 ... +85 °C
Continuous operating temperature	-60 ... +105 °C

Commercial data

Product Group	1 (Rail Mounted Terminal Blocks)
eCl@ss 10.0	27-14-11-28
eCl@ss 9.0	27-14-11-28
ETIM 8.0	EC000900
ETIM 7.0	EC000900
PU (SPU)	10 pcs
Packaging type	box
Country of origin	CN
GTIN	4045454193829
Customs tariff number	85369010000

Environmental Product Compliance

RoHS Compliance Status	Compliant, No Exemption
------------------------	-------------------------

Approvals / Certificates



General approvals

Logo	Approval	Additional Approval Text	Certificate name
	CCA	EN 60947	2143311.03



Subject to changes. Please also observe the further product documentation!

DEKRA Certification B.V.





	CCA DEKRA Certification B.V.	EN 60947	NTR NL 6828
	CSA DEKRA Certification B.V.	C22.2	1565649

Declarations of conformity and manufacturer's declarations

Logo	Approval	Additional Approval Text	Certificate name
	EU-Declaration of Conformity WAGO GmbH & Co. KG	-	-
	UK-Declaration of Conformity WAGO GmbH & Co. KG	-	-

Required accessories

End plate

End plate	Item no.:	Description	Link
	270-320	End and intermediate plate; 1 mm thick; for quadruple-deck terminal blocks; gray	www.wago.com/270-320
	270-322	End and intermediate plate; 1 mm thick; for quadruple-deck terminal blocks; orange	www.wago.com/270-322

Optional accessories

Insulation stop

Insulation stop	Item no.:	Description	Link
	280-472	Insulation stop; 0.75 - 1 mm ² ; 5 pieces/strip; black	www.wago.com/280-472

Subject to changes. Please also observe the further product documentation!



Item no.: 280-470
Insulation stop; 0.08 - 0.2 mm² "s" (0.14 mm² "f-st"); 5 pieces/strip; white

www.wago.com/280-470



Item no.: 280-471
Insulation stop; 0.25 - 0.5 mm²; 5 pieces/strip; light gray

www.wago.com/280-471

Ferrule

Ferrule

	Item no.: 216-123 Ferrule; Sleeve for 1 mm ² / AWG 18; uninsulated; electro-tin plated; silver-colored	www.wago.com/216-123
	Item no.: 216-122 Ferrule; Sleeve for 0.75 mm ² / AWG 20; uninsulated; electro-tin plated; silver-colored	www.wago.com/216-122
	Item no.: 216-124 Ferrule; Sleeve for 1.5 mm ² / AWG 16; uninsulated; electro-tin plated	www.wago.com/216-124
	Item no.: 216-132 Ferrule; Sleeve for 0.34 mm ² / AWG 24; uninsulated; electro-tin plated	www.wago.com/216-132
	Item no.: 216-121 Ferrule; Sleeve for 0.5 mm ² / AWG 22; uninsulated; electro-tin plated; silver-colored	www.wago.com/216-121
	Item no.: 216-131 Ferrule; Sleeve for 0.25 mm ² / AWG 24; uninsulated; electro-tin plated; silver-colored	www.wago.com/216-131
	Item no.: 216-223 Ferrule; Sleeve for 1 mm ² / AWG 18; insulated; electro-tin plated; red	www.wago.com/216-223
	Item no.: 216-222 Ferrule; Sleeve for 0.75 mm ² / 18 AWG; insulated; electro-tin plated; gray	www.wago.com/216-222
	Item no.: 216-221 Ferrule; Sleeve for 0.5 mm ² / 20 AWG; insulated; electro-tin plated; white	www.wago.com/216-221
	Item no.: 216-224 Ferrule; Sleeve for 1.5 mm ² / AWG 16; insulated; electro-tin plated; black	www.wago.com/216-224
	Item no.: 216-321 Ferrule; Sleeve for 0.25 mm ² / AWG 24; insulated; electro-tin plated; yellow	www.wago.com/216-321
	Item no.: 216-322 Ferrule; Sleeve for 0.34 mm ² / 22 AWG; insulated; electro-tin plated; light turquoise	www.wago.com/216-322

Mounting

Cover carrier



Item no.: 709-167
Cover carrier; Type 1; incl. fixing/retaining screws and knurled nut; suitable for 279 to 282 and 880 Series rail-mounted terminal blocks; suitable for 264 Series miniature rail-mounted terminal blocks; suitable for 270 Series sensor and actuator terminal blocks; gray

www.wago.com/709-167

Cover

Subject to changes. Please also observe the further product documentation!



Item no.: 709-153

Cover; Type 1; suitable for cover carrier, type 1; 1 m long; transparent

www.wago.com/709-153

Marking accessories

Marking strip



Item no.: 709-196

Marking strips; for laser printer; translucent

www.wago.com/709-196



Item no.: 709-178

Marking strips; on reel; 7.5 mm wide; not stretchable; plain; snap-on type; white

www.wago.com/709-178



Item no.: 709-177

Marking strips; on reel; 7.5 mm wide; not stretchable; plain; snap-on type; translucent

www.wago.com/709-177

Marker



Item no.: 2009-115/000-002

WMB-Inline; for Smart Printer; 1500 pieces on roll; stretchable 5 - 5.2 mm; plain; snap-on type; yellow

www.wago.com/2009-115/000-002



Item no.: 2009-115/000-007

WMB-Inline; for Smart Printer; 1500 pieces on roll; stretchable 5 - 5.2 mm; plain; snap-on type; gray

www.wago.com/2009-115/000-007



Item no.: 2009-115/000-017

WMB-Inline; for Smart Printer; 1500 pieces on roll; stretchable 5 - 5.2 mm; plain; snap-on type; light green

www.wago.com/2009-115/000-017



Item no.: 2009-115/000-023

WMB-Inline; for Smart Printer; 1500 pieces on roll; stretchable 5 - 5.2 mm; plain; snap-on type; green

www.wago.com/2009-115/000-023



Item no.: 2009-115/000-024

WMB-Inline; for Smart Printer; 1500 pieces on roll; stretchable 5 - 5.2 mm; plain; snap-on type; violet

www.wago.com/2009-115/000-024



Item no.: 2009-145/000-006

Mini-WSB Inline; for Smart Printer; 1700 pieces on roll; stretchable 5 - 5.2 mm; plain; snap-on type; blue

www.wago.com/2009-145/000-006



Item no.: 2009-145

Mini-WSB Inline; for Smart Printer; 1700 pieces on roll; stretchable 5 - 5.2 mm; plain; snap-on type; white

www.wago.com/2009-145

Item no.: 2009-145/000-002

Subject to changes. Please also observe the further product documentation!

WAGO GmbH & Co. KG

Hansastr. 27







32423 Minden

Phone: +49571 887-0 | Fax: +49571 887-169

Email: info.de@wago.com | Web: www.wago.com

Do you have any questions about our products?

We are always happy to take your call at +49 (571) 887-44222.

	Mini-WSB Inline; for Smart Printer; 1700 pieces on roll; stretchable 5 - 5.2 mm; plain; snap-on type; yellow	www.wago.com/2009-145/000-002
	Item no.: 2009-145/000-007 Mini-WSB Inline; for Smart Printer; 1700 pieces on roll; stretchable 5 - 5.2 mm; plain; snap-on type; gray	www.wago.com/2009-145/000-007
	Item no.: 2009-145/000-005 Mini-WSB Inline; for Smart Printer; 1700 pieces on roll; stretchable 5 - 5.2 mm; plain; snap-on type; red	www.wago.com/2009-145/000-005
	Item no.: 2009-145/000-012 Mini-WSB Inline; for Smart Printer; 1700 pieces on roll; stretchable 5 - 5.2 mm; plain; snap-on type; orange	www.wago.com/2009-145/000-012
	Item no.: 2009-145/000-023 Mini-WSB Inline; for Smart Printer; 1700 pieces on roll; stretchable 5 - 5.2 mm; plain; snap-on type; green	www.wago.com/2009-145/000-023
	Item no.: 2009-145/000-024 Mini-WSB Inline; for Smart Printer; 1700 pieces on roll; stretchable 5 - 5.2 mm; plain; snap-on type; violet	www.wago.com/2009-145/000-024
	Item no.: 2009-115 WMB-Inline; for Smart Printer; 1500 pieces on roll; stretchable 5 - 5.2 mm; plain; snap-on type; white	www.wago.com/2009-115
	Item no.: 248-501/000-006 Mini-WSB marking card; as card; not stretchable; plain; snap-on type; blue	www.wago.com/248-501/000-006
	Item no.: 248-501/000-007 Mini-WSB marking card; as card; not stretchable; plain; snap-on type; gray	www.wago.com/248-501/000-007
	Item no.: 248-501/000-002 Mini-WSB marking card; as card; not stretchable; plain; snap-on type; yellow	www.wago.com/248-501/000-002
	Item no.: 248-501/000-012 Mini-WSB marking card; as card; not stretchable; plain; snap-on type; orange	www.wago.com/248-501/000-012
	Item no.: 248-501 Mini-WSB marking card; as card; not stretchable; plain; snap-on type; white	www.wago.com/248-501

Subject to changes. Please also observe the further product documentation!



Item no.: 248-501/000-017
Mini-WSB marking card; as card; not stretchable; plain; snap-on type; light green

www.wago.com/248-501/000-017



Item no.: 248-501/000-005
Mini-WSB marking card; as card; not stretchable; plain; snap-on type; red

www.wago.com/248-501/000-005



Item no.: 248-501/000-024
Mini-WSB marking card; as card; not stretchable; plain; snap-on type; violet

www.wago.com/248-501/000-024



Item no.: 248-501/000-023
Mini-WSB marking card; as card; not stretchable; plain; snap-on type; green

www.wago.com/248-501/000-023



Item no.: 793-5501/000-007
WMB marking card; as card; for terminal block width 5 - 17.5 mm; stretchable 5 - 5.2 mm; plain; snap-on type; gray

www.wago.com/793-5501/000-007



Item no.: 793-5501/000-012
WMB marking card; as card; for terminal block width 5 - 17.5 mm; stretchable 5 - 5.2 mm; plain; snap-on type; orange

www.wago.com/793-5501/000-012



Item no.: 793-5501/000-017
WMB marking card; as card; for terminal block width 5 - 17.5 mm; stretchable 5 - 5.2 mm; plain; snap-on type; light green

www.wago.com/793-5501/000-017



Item no.: 793-5501/000-023
WMB marking card; as card; for terminal block width 5 - 17.5 mm; stretchable 5 - 5.2 mm; plain; snap-on type; green

www.wago.com/793-5501/000-023



Item no.: 793-5501/000-024
WMB marking card; as card; for terminal block width 5 - 17.5 mm; stretchable 5 - 5.2 mm; plain; snap-on type; violet

www.wago.com/793-5501/000-024



Item no.: 793-501/000-002
WMB marking card; as card; not stretchable; plain; snap-on type; yellow

www.wago.com/793-501/000-002



Item no.: 793-501/000-007
WMB marking card; as card; not stretchable; plain; snap-on type; gray

www.wago.com/793-501/000-007

Subject to changes. Please also observe the further product documentation!



Item no.: 793-501/000-017

WMB marking card; as card; not stretchable; plain; snap-on type; light green

www.wago.com/793-501/000-017



Item no.: 793-501/000-012

WMB marking card; as card; not stretchable; plain; snap-on type; orange

www.wago.com/793-501/000-012



Item no.: 793-501/000-023

WMB marking card; as card; not stretchable; plain; snap-on type; green

www.wago.com/793-501/000-023



Item no.: 793-501/000-006

WMB marking card; as card; not stretchable; plain; snap-on type; blue

www.wago.com/793-501/000-006



Item no.: 793-501/000-005

WMB marking card; as card; not stretchable; plain; snap-on type; red

www.wago.com/793-501/000-005



Item no.: 793-501

WMB marking card; as card; not stretchable; plain; snap-on type; white

www.wago.com/793-501



Item no.: 793-501/000-024

WMB marking card; as card; not stretchable; plain; snap-on type; violet

www.wago.com/793-501/000-024



Item no.: 793-5501/000-005

WMB marking card; as card; for terminal block width 5 - 17.5 mm; stretchable 5 - 5.2 mm; plain; snap-on type; red

www.wago.com/793-5501/000-005



Item no.: 793-5501/000-002

WMB marking card; as card; for terminal block width 5 - 17.5 mm; stretchable 5 - 5.2 mm; plain; snap-on type; yellow

www.wago.com/793-5501/000-002



Item no.: 793-5501/000-006

WMB marking card; as card; for terminal block width 5 - 17.5 mm; stretchable 5 - 5.2 mm; plain; snap-on type; blue

www.wago.com/793-5501/000-006





Item no.: 793-5501

WMB marking card; as card; for terminal block width 5 - 17.5 mm; stretchable 5 - 5.2 mm; plain; snap-on type; white

www.wago.com/793-5501

Subject to changes. Please also observe the further product documentation!

	Item no.: 2009-115/000-012 WMB-Inline; for Smart Printer; 1500 pieces on roll; stretchable 5 - 5.2 mm; plain; snap-on type; orange	www.wago.com/2009-115/000-012
---	--	--

	Item no.: 2009-115/000-006 WMB-Inline; for Smart Printer; 1500 pieces on roll; stretchable 5 - 5.2 mm; plain; snap-on type; blue	www.wago.com/2009-115/000-006
---	--	--

Jumpers

Jumper

	Item no.: 270-417 Jumper; 17-way; silver-colored	www.wago.com/270-417
--	--	--

	Item no.: 270-480 Jumper; 80-way; silver-colored	www.wago.com/270-480
--	--	--

	Item no.: 270-409 Jumper; 9-way; silver-colored	www.wago.com/270-409
--	---	--

	Item no.: 870-402 Jumper; 2-way; insulated; light gray	www.wago.com/870-402
---	--	--

	Item no.: 870-404	www.wago.com/870-404
--	--------------------------	--

	Item no.: 870-405 Jumper; 5-way; insulated; light gray	www.wago.com/870-405
--	--	--

	Item no.: 870-407 Jumper; 7-way; insulated; light gray	www.wago.com/870-407
---	--	--

	Item no.: 870-408 Jumper; 8-way; insulated; light gray	www.wago.com/870-408
---	--	--

	Item no.: 870-403 Jumper; 3-way; insulated; light gray	www.wago.com/870-403
---	--	--

	Item no.: 870-409 Jumper; 9-way; insulated; light gray	www.wago.com/870-409
---	--	--

	Item no.: 870-406 Jumper; 6-way; insulated; light gray	www.wago.com/870-406
---	--	--

Tool

Operating tool

	Item no.: 210-657 Operating tool; Blade: 3.5 x 0.5 mm; with a partially insulated shaft; short; multicoloured	www.wago.com/210-657
---	---	--

Subject to changes. Please also observe the further product documentation!



Item no.: 210-720

Operating tool; Blade: 3.5 x 0.5 mm; with a partially insulated shaft; multicoloured

www.wago.com/210-720

Downloads

Documentation

Bid Text

270-574 X81 - Datei	2019 Feb 19	xml 3.3 kB	Download
------------------------	-------------	---------------	----------

270-574 doc - Datei	2017 May 31	doc 24.6 kB	Download
------------------------	-------------	----------------	----------

Additional Information

Technical Section Technical explanations		pdf 2.2 MB	Download
---	--	---------------	----------

CAD/CAE-Data

CAD data

2D/3D Models 270-574		URL	Download
----------------------	--	-----	----------

CAE data

EPLAN Data Portal 270-574		URL	Download
---------------------------	--	-----	----------

WSCAD Universe 270-574		URL	Download
------------------------	--	-----	----------

ZUKEN Portal 270-574		URL	Download
----------------------	--	-----	----------

Environmental Product Compliance

Compliance Search

Environmental Product Compliance 270-574 4-conductor sensor supply terminal block; Internal commoning, 9 A; with colored conductor entries; 2.5 mm ² ; CAGE CLAMP®; 2,50 mm ² ; orange		URL	Download
---	--	-----	----------

Subject to changes. Please also observe the further product documentation!

Installation Notes

Commoning

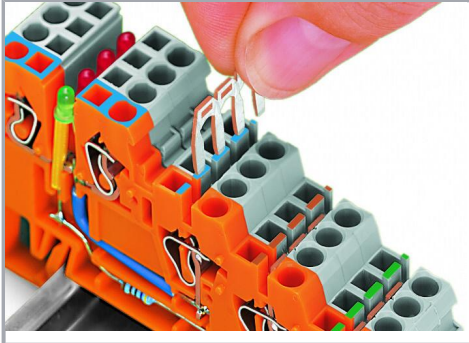

Inserting a jumper.

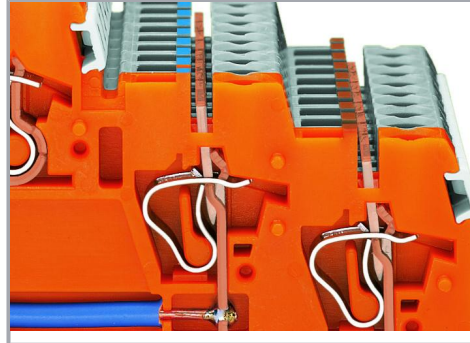

Commoning a supply voltage using uninsulated push-in type jumper bars, 2- to 9-way or 17-way (2 x 8 bits), depending on application.



Commoning signal level voltage via insulated push-in type jumper bars (870 Series) –

2- to 9-way, depending on application.

Sensor LED terminal blocks cannot be commoned!

Marking

Subject to changes. Please also observe the further product documentation!

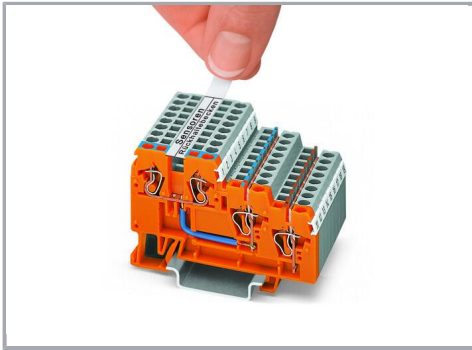

Marking strip (Item No. 709-196)

Not suitable for LED terminal blocks!

Subject to changes. Please also observe the further product documentation!