

CP4-92 SERIES

UP/DOWN COUNTER, BATCH COUNTER CHRONOMETER AND RATE CONTROLLER

- Backlit Green LCD or Red Illuminated Display
- Displays Actual and Preset Count
- 1/16 DIN-Sized (48 x 48mm) Housing



The CP4-92 Series is a programmable dual preset up/down counter, batch counter, chronometer and rate controller with relay outputs. The CP4-92 display shows both actual and preset values. Both count and preset values are saved in EEPROM memory. The unit provides a built-in sensor power supply of 12 VDC, 100mA and will accept contact or solid state inputs.

SPECIFICATIONS:

Input Power	80 to 260 VAC 20 to 55 VAC 10 to 30 VDC
Sensor Supply	12VDC 100mA
Display	5 digit, Green backlit LCD 5 digit, Red Illuminated -9999 to +99999
Display digit height	8mm - actual 4mm preset
Presets	2
Count Inputs	2 Inputs, IN1, IN2 Contact Closure, DC Voltage, NPN/PNP transistor Low Level: 0 to 1 VDC High Level: 4 to 30 VDC Impedance: 10 KΩ Low Speed: 30 Hz Max. High Speed: 5 kHz
Input Modes	Up IN1 - Count input DN IN1 - Count input IND IN1 - one direction IN2 - opposite direction DIR IN1 - Count input IN2 - Change in direction input CUMUL IN1 - Input IN2 - Same direction input Phase; Quadrature Up/Down Mode Phase x 2, Phase x 4
Reset Input	Dry contact, voltage, solid state: NPN/PNP front panel
Scale factor	Programmable from 0.001 to 99.999
Output	2 x 2 Amp SP N.O. Relay
Output Modes	Repeat or single cycle Maintained or pulsed output of 500ms.
Connections	Screw terminals: 2 x 1.5mm ²
Front Panel Rating	NEMA 12, IP54

CONFORMITY:

Immunity to interference and noise (EMC)	
IEC 1000.4.2	Level 3
IEC 1000.4.3 Radiated disturbance	Level 3
IEC 1000.4.4 Fast transient	Level 3
IEC 255.4	Level 3

RF Emissions (EMC)
CENELEC EN 55022; Class A

Vibration limits (in 3 axes)
IEC 68-2-6; 10-55Hz/.0375mm

WIRING:

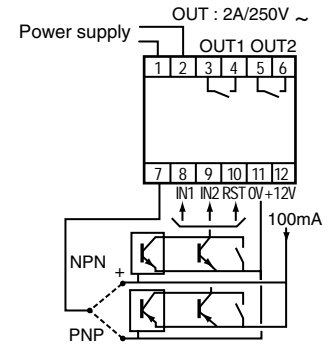

DIMENSIONS: inches (mm)

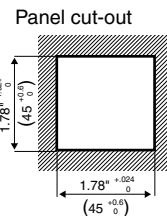
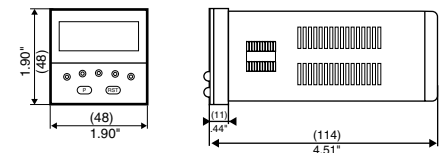

ORDERING INFORMATION:

Part Number	Input Voltage	Display
87 618 228	80 to 260 VAC	Backlit Green
87 618 224	20 to 55 VAC	Backlit Green
87 618 222	10 to 30 VDC	Backlit Green
87 618 328	80 to 260 VAC	Red Illuminated
87 618 324	20 to 55 VAC	Red Illuminated
87 618 322	10 to 30 VDC	Red Illuminated

Products and specifications subject to change without notice.
Consult factory for application assistance.

Batch counter function

Principle

P1 is the "batch" preset.

When P2 is displayed, the value displayed on the upper digits represents the current counter value (reset to P2).

In this configuration the "RST" key on the front panel reinitializes the current value.

When P1 (batch preset) is displayed, the value displayed on the upper digits represents the value of the Batch counter.

In this configuration the "RST" key on the front panel resets the batch counter.

An "electrical" reset (RST terminal) still resets the current counter value and that of the batch counter.

Example

On a packing line, bottles need to be counted into packs of 6 bottles and then dispatched in a box containing a batch of 4 packs.

P2: current counter preset value: 00006
P1: batch counter preset value: 00004

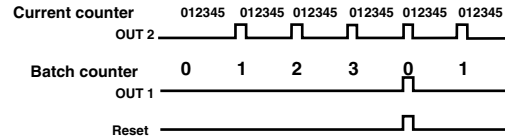

Tachometer function

Measurement principle

Measurement begins on a rising edge of the signal to be measured. The measurement time is greater than TR, but less than TL. Measurement stops at the end of the current period (3), after TR. If the period (3) does not end before TL, the measurement result will be zero (0).

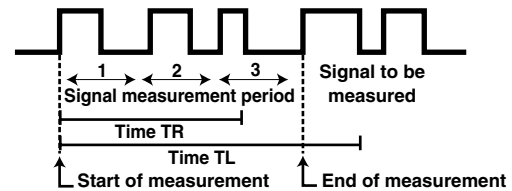

Measurement precision: $100 + (200 / TR)$ PPM
Example: for TR = 1s \rightarrow 300 PPM (0.03%)

The outputs are updated each time measurement ends according to the selected output mode.

- **Maintained output:** output active if the measured speed is greater than the preset speed.
- **Pulsed output:** output activated during time T, when the preset threshold is crossed.

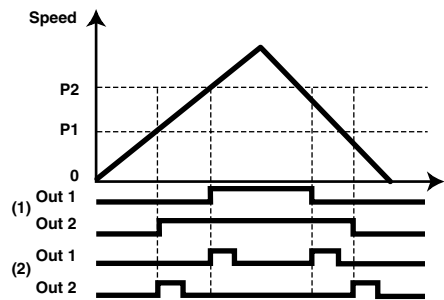
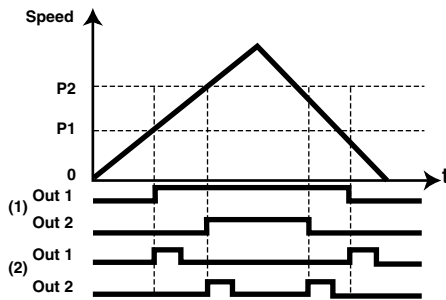

(1) Maintained output (2) Pulsed output

Chronometer function (Precision: 150 ppm)

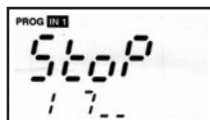

- 1 - Input IN1
- 2 - Display (0 \rightarrow PR), 1-channel pulse measurement
- 3 - Display (PR \rightarrow 0), 1-channel pulse measurement



Accessory

Adaptor frame: 79 237 807

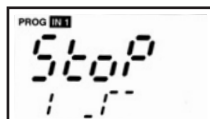

- 1 - Input IN1
- 2 - Display (0 \rightarrow PR), 1-channel pulse measurement
- 3 - Display (PR \rightarrow 0), 1-channel pulse measurement

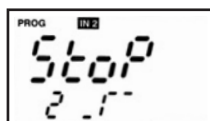
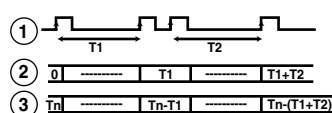

- 1 - Input IN1 (start counting)
- 2 - Input IN2 (stop counting)
- 3 - Display (0 \rightarrow PR), measurement on 2 separate channels
- 4 - Display (PR \rightarrow 0), measurement on 2 separate channels

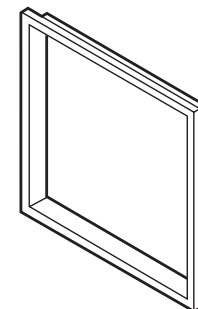
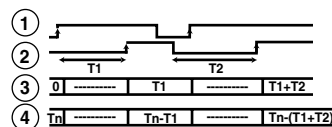

ø 49 x 50.5 mm

Products and specifications subject to change without notice.
Consult factory for application assistance.